



CONTROL PANEL

INSTALLATION MANUAL



Electronics Line

infinite Installation Manual - Version 2.00  
Catalog Number: Z10249C (6/03)

All data is subject to change without prior notice.

Hereby, Electronics Line 3000 Ltd. declares that this control panel is in compliance with the essential requirements and other relevant provisions of Directive 1999/5/EC. 868.35MHz frequency transmitters are not intended for use in Bulgaria, Greece, Poland and Slovenia.



# Table of Contents

---

Chapter One: Introduction .....	5
1.1: Documentation Conventions .....	5
1.2: Specifications .....	6
1.3: System Overview .....	6
1.4: Hardware Layout .....	8
Chapter Two: System Installation .....	12
2.1: Planning the Installation .....	12
2.2: Opening the Housing .....	13
2.3: Mounting the Control Panel .....	13
2.4: Back Tamper .....	14
Chapter Three: Basic System Operation .....	15
3.1: Front Panel Layout .....	15
3.2: System Status LEDs .....	15
3.3: Alphanumeric Keypad .....	16
3.4: LCD Display .....	16
3.5: Arming/Disarming .....	17
3.6: Remote Arming/Disarming via SMS .....	19
3.7: Front Panel Alarm Activation .....	19
Chapter Four: Advanced System Operation .....	21
4.1: Menu Navigation .....	21
4.2: Stop Communications .....	21
4.3: Sensor Bypassing/Unbypassing .....	22
4.4: User Codes .....	22
4.5: Follow Me .....	24
4.6: Event Log .....	24
4.7: Service Menu .....	25
Chapter Five: Two-Way Audio .....	28
5.1: Incoming Calls .....	28
5.2: Outgoing Calls .....	29
Chapter Six: Home Automation Control .....	31
6.1: Keypad Control .....	31
6.2: Keyfob Control .....	31
6.3: SMS Control .....	31
6.4: Scheduling .....	32
Chapter Seven: Devices .....	33
7.1: Device Registration .....	33
7.2: Device Descriptors .....	33
7.3: Device Deletion .....	34
7.4: Supervision Time .....	34
7.5: Re-Synchronization .....	34
7.6: Zones .....	34
7.7: Keyfobs .....	37
7.8: Smartkeys (for future use) .....	38
7.9: Keypads .....	38
7.10: External Siren .....	39
Chapter Eight: Entry/Exit Timers and Arming Tones .....	41
8.1: Entry/Exit Delay .....	41
8.2: Arm on Exit .....	41
8.3: Arming Tones .....	41

- Chapter Nine: System Options ..... 43
  - 9.1: Swinger Setting ..... 43
  - 9.2: Code Lockout ..... 43
  - 9.3: Forced Arm ..... 43
  - 9.4: HA Control ..... 43
  - 9.5: Panic Alarm ..... 44
  - 9.6: One-Key Arming ..... 44
  - 9.7: Supplementary Entry Delay ..... 44
  - 9.8: Entry Deviation ..... 44
  - 9.9: AC Loss Delay ..... 45
  - 9.10: Arm Status Display ..... 45
  - 9.11: Banner ..... 45
  - 9.12: PGM Output ..... 46
  - 9.13: Guard Code (for future use) ..... 47
- Chapter Ten: Communications ..... 48
  - 10.1: Accounts ..... 48
  - 10.2: General Account Options ..... 49
  - 10.3: Remote Programming ..... 50
  - 10.4: Service Call ..... 52
  - 10.5: SMS Center ..... 52
  - 10.6: Communications Options ..... 53
  - 10.7: Two-Way Audio Options ..... 55
  - 10.8: GSM RX Report ..... 55
  - 10.9: Event Options ..... 56
- Chapter Eleven: Home Automation Programming ..... 57
  - 11.1: X10 Overview ..... 57
  - 11.2: HA Units ..... 57
  - 11.3: House Code ..... 59
  - 11.4: SMS Confirmation ..... 59
- Chapter Twelve: System Initialization ..... 60
  - 12.1: Initialization ..... 60
  - 12.2: Default Program Restore ..... 60
  - 12.3: Clear User Codes ..... 60
  - 12.4: Clear Wireless Transmitters ..... 60
  - 12.5: Find Modules ..... 61
- Appendix A: Menu Structure ..... 62
- Appendix B: Transmitter Installation ..... 67
  - PIR Sensors (EL-2600/EL-2600PI) ..... 67
  - Magnetic Contact (EL-2601) ..... 69
  - Smoke Detector (EL-2603) ..... 70
  - Keyfobs (EL-2611/EL-2614) ..... 71
  - Wireless Keypads (EL-2620/EL-2640) ..... 72
  - Transmitter Specifications ..... 74

# Chapter One: Introduction

This manual is designed to help you install the *infinite* control panel. We strongly urge you to read through this manual, in its entirety, before beginning the installation process so that you can best understand all that this security system has to offer. This manual is not intended for end user use. End users are encouraged to read the user manual provided with the system. If you have any questions concerning any of the procedures described in this manual please contact Electronics Line 3000 Ltd. at (+972-3) 918-1333.

## 1.1: Documentation Conventions

Throughout the manual, we have tried to include all of the operating and programming functions using a similar structure and order as they appear in the menu. A detailed explanation of how to navigate the panel's menu is included in section 4.1: Menu Navigation. In order to simplify the procedures that appear in the rest of this manual, the following conventions are used:

This...	Means...
Select...	Use the arrow keys to scroll through the options and press ✓.
From the Event Log Menu, select Clear Log.	Enter the main menu by pressing ✓ and entering your user code. Using the arrow keys, navigate until you reach Event Log and press ✓. Using the arrow keys, navigate until you reach Clear Log and press ✓.
From the Service menu, select Time/Date, Set Date.	The same as above only this time you are navigating through three menu levels.
[712]	The shortcut to a specific menu item from the main menu. In this case, this is the shortcut for Set Date. These appear in the procedures as an additional aid to menu navigation.
[#5]	A shortcut to a specific item in a sub-menu. For example, [#5] is the shortcut to Bell enable/disable in the sub-menu that is opened once you have selected the sensor you want to program.
✓	The symbol on a key that appears on the keypad
<b>4. Speaker Test</b>	The text that actually appears on the LCD display (bold italics).
	Important note, please pay attention.

Table 1.1: Documentation Conventions

## 1.2: Specifications

### General

Zones: 32 wireless zones (1 transmitter per zone), 1 hardwire zone (Zone 33)  
Wireless Keyfobs: 8 (Controlled or Non-controlled)  
Wireless Keypads: 4  
Smartkeys (future option): 16 (Controlled or Non-controlled)  
User Codes: 32  
Arming Methods: Full, Part or Perimeter  
Event Log: 256 event capacity, time and date stamped

### Communications

Accounts: 3 (8-digit account number)  
Telephone Numbers: 3 regular, RP Callback and Service Call (16-digits each)  
Communication Interface Options: PSTN or GSM (optional expansion module required)

### Home Automation

Control Medium: Power-line carrier  
Protocol: X10  
HA Units: 16 individually addressed

### Receiver

Type: Super-heterodyne, fixed frequency  
Frequency: 868.35, 433.92 or 418MHz FM  
Data Encryption: SecuriCode™

### Electrical

Power Input: 230VAC, 50Hz  
Backup Battery Pack: 7.2V/1.2Ah (6 x 1.2V Ni-MH rechargeable cells, size AA)  
Fuse Ratings: 63mA/250V (AC protection fuse), 1A/250V (battery protection fuse)  
PGM Relay Output Contact Rating: 100mA (max. load)  
Internal Sounder: 105dB or 85dB  
Tamper Switch: N.C.  
Operating Temperature: 0-60°C

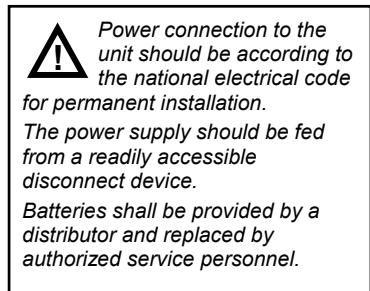

## 1.3: System Overview

The *infinite* is a full-featured wireless control panel that is expected to provide a solution to the needs of most residential installations. This system has been developed based upon a design concept geared towards easy installation and use. With this in mind, the user interface is based on a simple, menu-driven model that suits the essential requirements of both the user and installer alike. You can program the *infinite* on-site using the on-board LCD keypad or off-site via a PC using the up/downloading software.

Central station communication and up/downloading employ either regular PSTN or high-speed cellular communication. SMS messaging provides an innovative method used for both central station and Follow-me user monitoring. Additionally, SMS messages can be sent to the panel enabling the user to send commands to the system from anywhere on the planet.

The panel's home automation capabilities provide a wealth of features. The Home Automation module interfaces with X10 units over the powerline network and grants the user appliance control via a number of different media.

The following diagram shows the components that make up the system and the system's interaction with external communication networks.

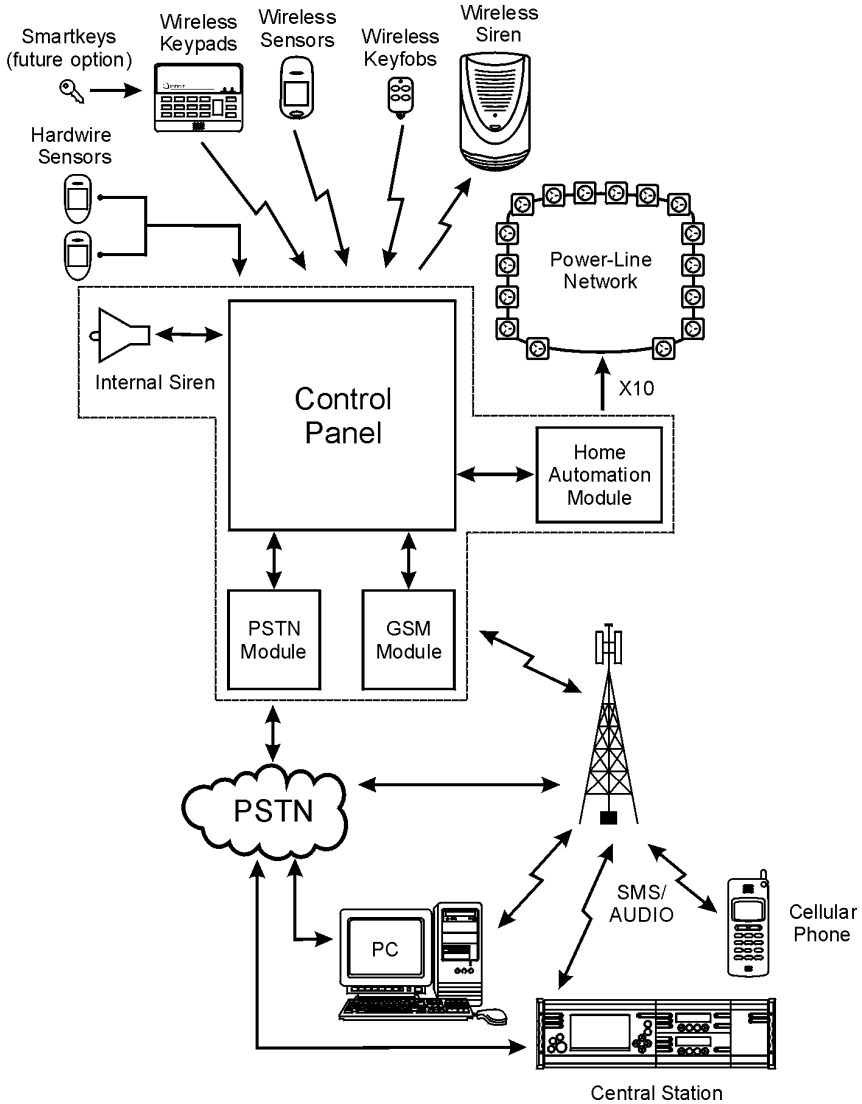

Figure 1.1: System Architecture

## 1.4: Hardware Layout

The aim of this section is to acquaint you with the various circuit boards that make up the system. Apart from the Main Board, each peripheral module is available as an optional extra designed for installation inside the plastic housing.

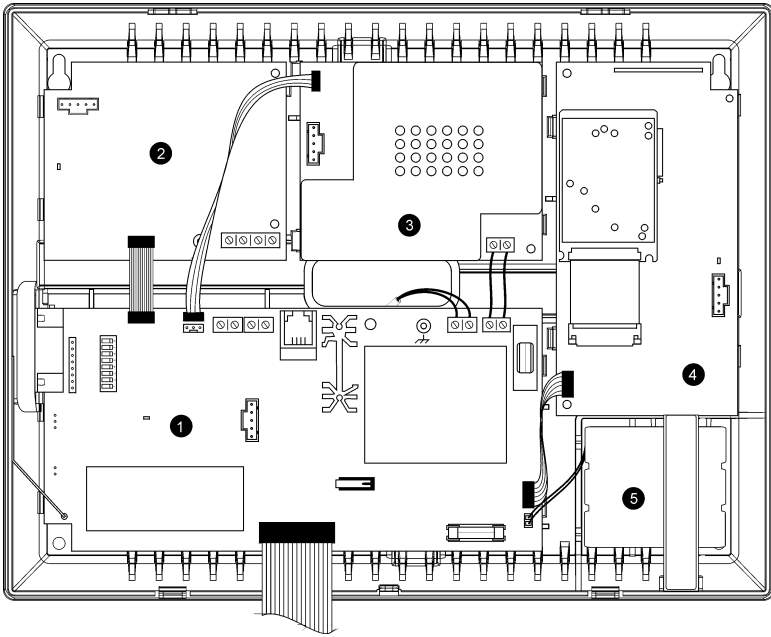

Figure 1.2: System Layout

1. Main Board
2. PSTN dialer module (optional)
3. Home Automation module (optional)
4. Cellular communications module (optional)
5. Backup battery pack



### 1.4.1: The Main Board

The Main Board is the brain of the system and connects to various peripheral modules using a number of interface connectors. Additionally, the Main Board includes a programmable output, a hardwire zone input, an external microphone/speaker connection and a standard 9-pin serial port for PC programming.

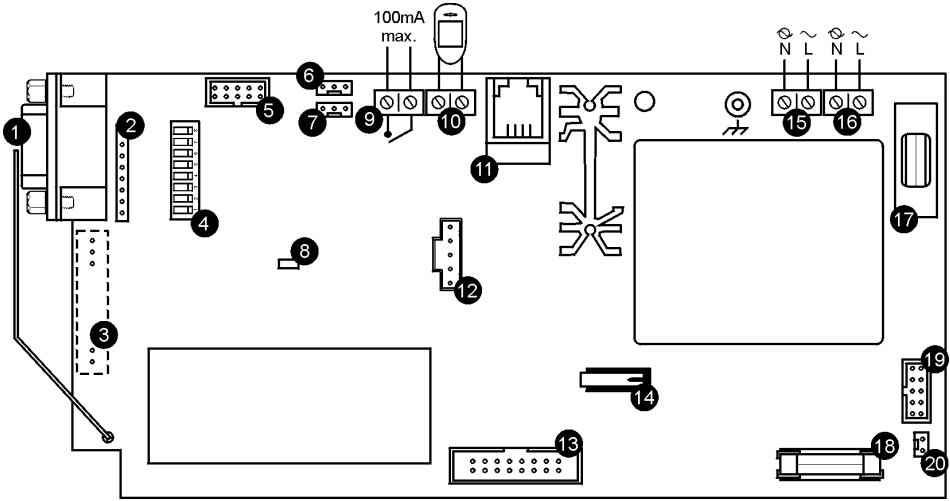

Figure 1.3: Main Board

1. 9-pin port for connection to PC
2. Header for plug-in Serial Interface board
3. Connector for on-board transmitter
4. DIP-switch for flash programming
5. Flat-cable interface connector to PSTN module
6. Interface connector to Home Automation module
7. Programming keypad connector
8. Status LED
9. Programmable relay output (100mA max. load)
10. Hardwire zone
11. External microphone and speaker connector (for future use)
12. Flash programming connector for main board
13. Flat-cable interface connector to LCD keypad, internal speaker, internal microphone and internal siren
14. Front tamper switch
15. AC power terminal block
16. Home Automation module terminal block
17. AC power protection fuse
18. Backup battery protection fuse
19. Flat-cable interface connector to GSM module
20. Backup battery connector

### 1.4.2: PSTN Module

The PSTN module provides the system with a standard dialer for central station communications via the Public Switched Telephone Network (PSTN).

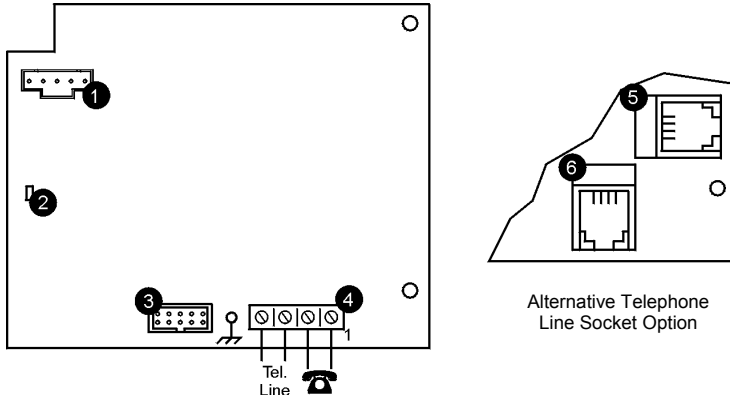

Figure 1.4: PSTN Module

1. Flash programming connector
2. Status LED
3. Flat-cable interface connector to Main Board
4. Telephone line terminal block (Terminals 1 & 2: Outgoing line to telephone, Terminals 3 & 4: Incoming line from telephone company)
5. Telephone socket for outgoing line to telephone
6. Telephone socket for incoming line from telephone company

### 1.4.3: Home Automation Module

The Home Automation module provides the system with an interface to the power-line network, enabling control over 16 home automation units employing the X10 protocol.

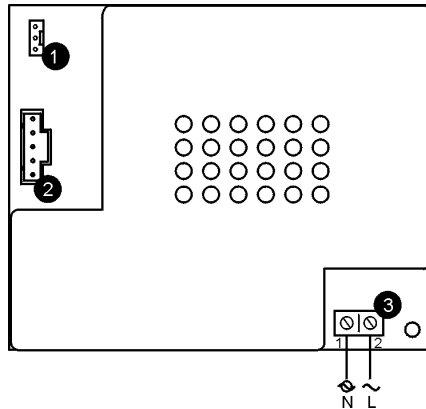

Figure 1.5: Home Automation Module

1. Interface connector to Main Board
2. Flash programming connector
3. Power-line terminal connections to Main Board (1 - Neutral; 2 - Live)

#### 1.4.4: Cellular Communications Module

The Cellular Communications module enables the control panel to communicate via cellular networks. This offers the ability to send or receive SMS messages, perform up/downloading and implement cellular 2-way voice applications.

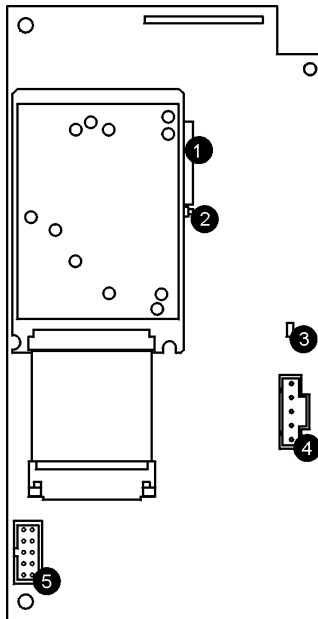

Figure 1.6: Cellular Communications Module

1. SIM card holder
2. SIM card release
3. Status LED
4. Flash programmer connector
5. Flat-cable interface connector to Main Board

# Chapter Two: System Installation

## 2.1: Planning the Installation

When planning the installation, consider the following guidelines:

- Whenever possible, mount the panel centrally in relation to wireless sensors.
- Avoid installation in close proximity to sources of high noise or radio frequency interference. For example, metal air conditioner/heater ducts and circuit breaker boxes.
- Minimize the distance between the panel and transmitters.
- Minimize the number of obstacles between the panel and transmitters.

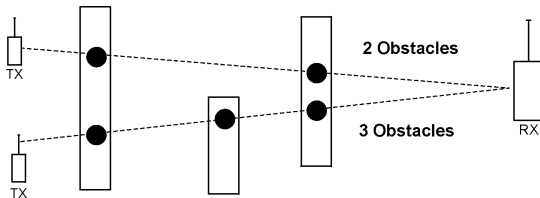

Figure 2.1: Minimizing Obstacles

- Metal based construction materials, such as steel reinforced concrete walls, reduce the range of radio transmissions.

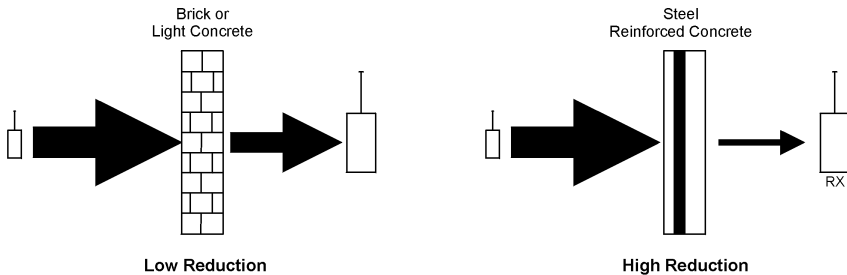

Figure 2.2: Considering Construction Materials

- The reduction of the RF signals' strength is directly proportional to the thickness of the obstacle, assuming that the obstacles are of identical material.

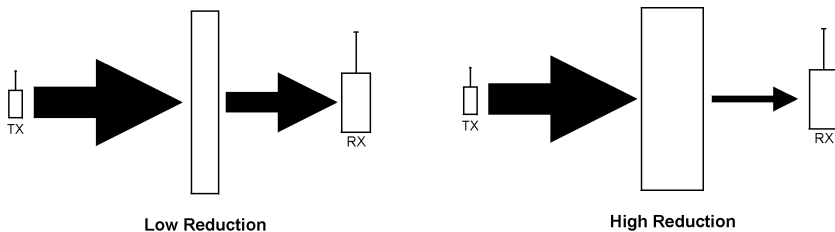

Figure 2.3: Considering Thickness of Obstacles

### 2.1.1: Considerations for Cellular installations

In addition to the above-mentioned guidelines for wireless installations, you must also consider the physical location of the control panel if installing with the Cellular Communications module – see 4.7.8: *GSM Signal Strength*.

### 2.2: Opening the Housing

To open the housing:

1. Remove the housing screw located at the bottom of the front cover.
2. Using a screwdriver carefully press the release tabs as shown in Figure 2.4.
3. Lift the front cover away from the back of the housing. You will notice that the front cover is attached to the back with two fastening bands and the keypad's flat cable.

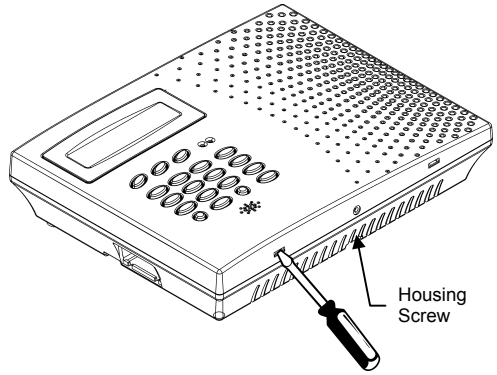

Figure 2.4: Opening the Housing

### 2.3: Mounting the Control Panel

Once you have decided where to locate the control panel according to the guidelines in section 2.1: Planning the Installation, you are ready to mount the control panel.

For further information on the layout and function of each board within the housing, see section 1.4: Hardware Layout.

To mount the control panel:

1. Open the housing as explained in section 2.2: Opening the Housing.
2. Disconnect the flat cable connecting the main panel to the keypad.
3. Detach the front and back covers by unfastening the bands that connect them.
4. Remove the backup battery pack. If you want to install the control panel with back tamper, it is also necessary to remove the main board.

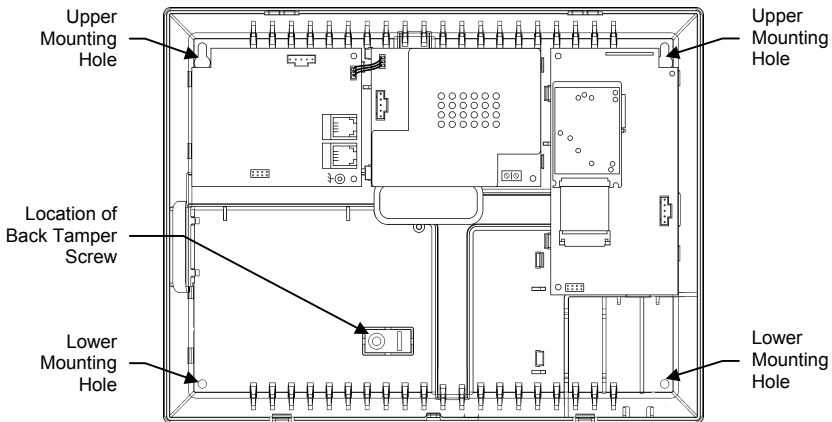

Figure 2.5: Back Cover (Main Board and Battery Pack removed)

5. Place the control panel in position against the wall and mark the upper and lower mounting holes. If using the back tamper, also mark the hole for the back tamper screw.
6. Install wall anchors in the appropriate positions and mount the control panel to the wall.
7. Replace the Main Board, reconnect its peripheral modules and battery pack.
8. Connect the flat cable and fastening bands to the front cover.
9. Position the front cover's top holding hooks onto the back cover and snap the front cover closed.

## 2.4: Back Tamper

The back tamper switch is an optional feature that provides an extra safeguard in the event that the control panel is removed from the wall.

The back tamper switch is located on the rear side of the control panel's Main Board and is constantly depressed by the section of the back cover shown in Figure 2.6.

For this feature to operate, you must insert a screw into the back tamper mounting hole – see section 2.3: *Mounting the Control Panel*. When the control panel is removed from the wall, the screw causes the perforated section of the plastic to break and remain attached to the wall. As a result, the back tamper switch is released and an alarm is generated.

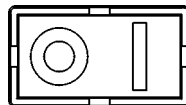

Figure 2.6: Perforated Back Tamper Release

# Chapter Three: Basic System Operation

## 3.1: Front Panel Layout

The front panel provides a detailed interface for operating and programming the system. The following diagram will familiarize you with the various elements on the front panel.

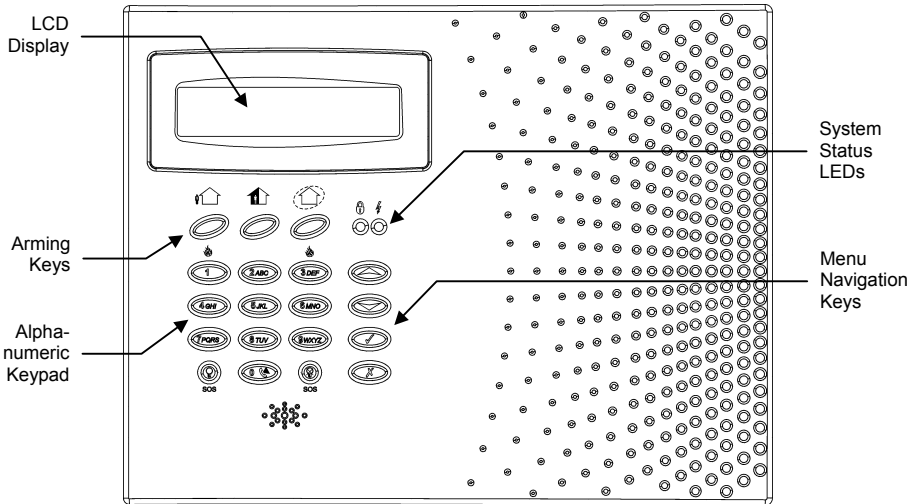

Figure 3.1: Front Panel

## 3.2: System Status LEDs

The two LEDs, Armed and Power, provide essential information on the status of the system.

If the Armed LED is...	It means...
Off	The system is disarmed.
On	The system is armed.
Flashing	An alarm has occurred. Alarm indication is cleared the next time that an arming sequence is initiated or after the relevant event has been viewed in the event log.

Table 3.1: Armed LED Indication



*Alarm indication is not displayed after a silent panic alarm.*

If the Power LED is...	It means...
Off	Both AC and Battery power are disconnected.
On	System Power is OK.
Flashing (slow)	Backup battery low.
Flashing (fast)	AC loss.

Table 3.2: Power LED Indication

### 3.3: Alphanumeric Keypad

The alphanumeric keypad on the front panel enables you to perform various operation and programming tasks. Apart from the regular functions of a standard alphanumeric keypad, the keypad offers a number of special functions. These functions are listed in the following table.

Key	Special function
1	Used to enter symbols in descriptor editing.
0	Used to enter symbols in descriptor editing.
X	Used to cancel the current selection. Used to return to the previous menu level.
✓	Used to enter Menu mode. Used to select the current menu item. Used to signify the end of an entered value. Toggles status in Zone Bypass/Unbypass function.
💡	In descriptor editing, used to insert a space before the current character. In phone number editing, used to enter "T", ",", "P", "+". Toggles item descriptors and default names. In the event log, toggles the time/date stamp.
⊗	In descriptor and phone number editing, used to delete the current character.
⬆	Used to scroll backwards in the current menu level
⬇	Used to scroll forwards in the current menu level. During standby, used to scroll through the list of system trouble conditions.

Table 3.3: Keypad Functions

### 3.4: LCD Display

The LCD display provides you with a detailed interface for operation and programming.

#### 3.4.1: Standby Mode

Standby mode can be defined as the state the system is in when it is disarmed and not in Menu mode. In Standby mode, the armed status, system status or banner are displayed. If system status is normal, the current time is displayed.



Figure 3.2: Typical Standby Display

This...	Means...
DISARMED	The system is disarmed.
FULL ARMED	The system has been armed using the displayed arming method.
PART ARMED	
PERIMETER ARMED	
FULL ARMING	The system is in the process of arming (displayed during exit delay).
PART ARMING	
PERIMETER ARMING	

Table 3.4: Armed Status



This...	Means...
ZONES IN ALARM	Zones have been violated.
TAMPER ALARM	The system has been tampered with.
EXIT NOW 056	The exit delay is counting down (56 seconds remaining).
DISARM NOW 011	The entry delay is counting down (11 seconds remaining).
SYSTEM NOT READY	The system is not ready to arm, check that all doors and windows are closed.
KEYPAD LOCKED	Five unsuccessful attempts were made to enter a user code, the keypad is locked for 30 minutes.
SYSTEM TROUBLE	A trouble condition has been detected, press ▼ for further details.

Table 3.5: System Status

### 3.5: Arming/Disarming

The following section explains how to arm and disarm the control panel using the LCD keypad.

The *infinite* offers three arming modes that you can define to suit the application. Figure 3.3 illustrates the three arming modes. In each diagram, the protected area is shaded.

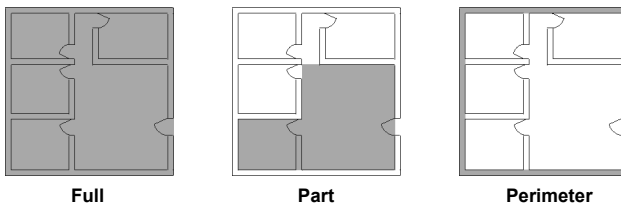

Figure 3.3: Arming Modes

The arming options are entirely flexible. You can program each sensor to be included in any combination of the three arming modes – see *section 7.6.2: Arm Set*. Additionally, each arming mode has a separate exit and entry delay.

The arming functions are only available while the system is in Standby mode.

#### 3.5.1: Arming Keys

The Arming keys enable you to arm the system using any of the three arming methods: Full, Part and Perimeter.

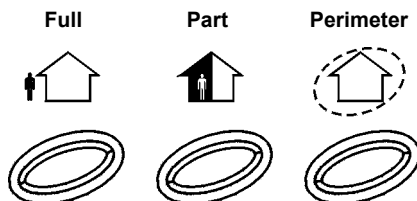

Figure 3.4: Arming Keys

### 3.5.2: Full Arming

Full arming is designed for when the occupant vacates the premises.

To fully arm the system:

1. Check if the system is ready to arm.
2. Press the Full arming key on the keypad.
3. If One-Key Arming is disabled, enter your user code.

### 3.5.3: Part Arming

Part arming is designed for when the occupant intends to remain inside one part of the premises and secure another part.

To partially arm the system:

1. Check if the system is ready to arm.
2. Press the Part arming key on the keypad.
3. If One-Key Arming is disabled, enter your user code.

### 3.5.4: Perimeter Arming

Perimeter arming is designed for when the occupant intends to remain inside the premises and secure the perimeter.

To arm the system's perimeter:

1. Check if the system is ready to arm.
2. Press the Perimeter arming key on the keypad.
3. If One-Key Arming is disabled, enter your user code.

### 3.5.5: Combination Arming

The system allows you to activate a combination of two arming modes. If you Perimeter arm the system, you may also activate Full or Part arming. Likewise, you can Perimeter arm the system after activating Full or Part arming. It is not important which arming mode you choose first.

You can activate the second arming mode during the exit delay of the first arming mode. If the first exit delay expires, you cannot activate a second arming mode.

To arm the system using two arming modes:

1. Check if the system is ready to arm.
2. Activate the first arming mode.
3. If One-Key Arming is disabled, enter your user code.
4. While the exit delay of the first arming mode is counting down, activate the second arming mode.
5. If One-Key Arming is disabled, enter your user code.



*It is not possible to activate Full and Part arming modes simultaneously.*

The exit delays of the two arming modes are entirely independent. The moment an arming mode is activated, its exit delay begins to count down. The entry delay depends on which sensor was tripped first. For example, if the sensor is included in Perimeter arming, the entry delay for Perimeter arming counts down – see 7.6.2: *Arm Set*.

If, due to open zones, the system is not ready to activate the second arming mode then both arming methods are canceled. In this case, check that the relevant entrances are secured and start the entire arming sequence again.

Disarming cancels both active arming modes.

### 3.5.6: Forced Arming

Forced arming enables you to arm the system when the system is not ready. For example, if a door protected by a magnetic contact is open, you may arm the system on condition that the door will be closed by the end of the Exit delay. If the door is still open after the exit delay expires, an alarm is generated.

Two conditions enable you to perform Forced arming:

- Forced arming is enabled – see section 9.3: *Forced Arm*.
- The sensor that is causing the System Not Ready condition is Forced Arm enabled – see section 7.6.5: *Force Arm*.

### 3.5.7: Disarming

When a sensor is tripped, the entry delay counts down; each arming method has its own entry delay.

To disarm the system:

- Enter a valid user code.

## 3.6: Remote Arming/Disarming via SMS

You can arm and disarm the system remotely by sending the SMS commands from a cellular phone to the cellular communications module.

Each SMS command contains the following elements:

- ① SMS Command Descriptor (up to 43 characters of free text)
- ② # (delimiter – separates the descriptor from the actual command)
- ③ User Code (4 digits)
- ④ Command (120=Disarm, 121=Full Arm, 122=Part Arm, 123=Perimeter Arm, 124=Full + Perimeter Arm, 125=Part + Perimeter Arm)

The following example shows the format of an SMS command for disarming the system:

①					②	③				④		
F	u	l	l		#	1	2	3	4	1	2	0



While the SMS Command Descriptor is optional, you must start the SMS command with the # symbol for the system to accept the command.

## 3.7: Front Panel Alarm Activation

In the event of an emergency, the user can generate two kinds of alarm from the front panel.

To activate an SOS alarm:

- Press both Home Automation keys simultaneously.

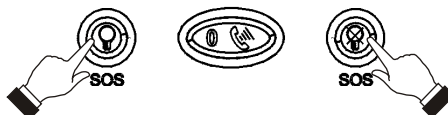
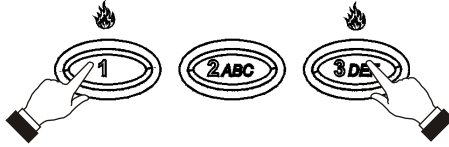

Figure 3.5: SOS Alarm Activation

To activate a Fire alarm:

- Press keys 1 and 3 simultaneously.



**Figure 3.6: Fire Alarm Activation**

# Chapter Four: Advanced System Operation

Besides the basic arming functions described in the previous chapter, you can access additional functions via the menu. This chapter describes these functions and the menu navigation procedure.

## 4.1: Menu Navigation

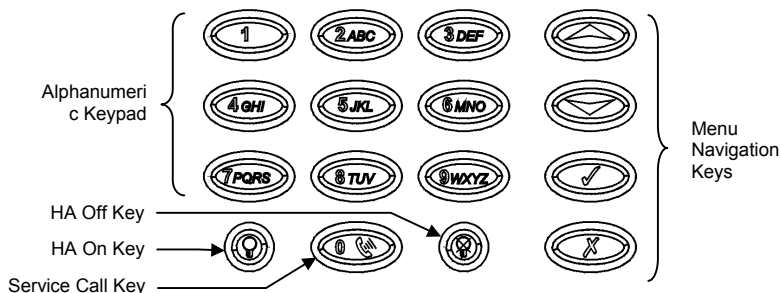

Figure 4.1: On-board Keypad Layout

The LCD keypad's friendly, menu-driven interface is designed to facilitate operation and provide a gentler learning curve for first-time users. You can navigate through the menus using the arrow navigation keys (▲/▼) and make simple yes/no decisions using the ✓ and X keys.

For example, perform the following procedure to navigate to Service, Speaker Test.

1. Press ✓ to enter Menu mode.
2. Enter an authorized user code; the first menu item, **1. Stop Comm.**, is displayed.
3. Press ▼ until **7. Service** is displayed.
4. Press ✓ to enter the Service menu.
5. Press ▼ until **4. Speaker Test** is displayed.
6. Press ✓ to choose the displayed function.

As an alternative to scrolling through menu options, you may enter a function's shortcut once you have entered Menu mode. Shortcut numbers appear in square brackets in the procedures throughout this manual.



*Press the X key to return to the previous menu level. Press this key when you are in the main menu to exit Menu mode.*

### 4.1.1: Menu Mode Timeout

Menu mode automatically terminates a certain amount of time after the last keystroke. The duration of this timeout depends upon which code is used to enter the menu. Usually the Menu Mode Timeout is two minutes but if you enter menu mode using the Installer code, the timeout is extended to fifteen minutes.

## 4.2: Stop Communications

To stop communications:

- From the main menu, select Stop Com. [1]; all communication buffers are cleared and all pending messages are canceled.

### 4.3: Sensor Bypassing/Unbypassing

When a sensor is bypassed, it is ignored by the system and does not generate an alarm when triggered.

To bypass or unbypass a sensor:

1. From the Bypass Zones menu, select Bypass/Unbyp. [21].
2. Using the arrow keys, scroll to the sensor you want to bypass or unbypass.
3. Press ✓ to change the bypass status.
4. Press X ; **Save Changes?** is displayed.
5. Press ✓ to confirm the changed bypass status.

To unbypass all sensors:

1. From the Bypass Zones menu, select Unbypass All [22].
2. Press ✓ ; all sensors are unbypassed



*All bypassed zones will be automatically unbypassed when the system is disarmed.  
A fire zone cannot be bypassed.*

### 4.4: User Codes

The control panel supports up to 32 individual user codes. Each of these codes is four digits long. Most system operations require you to enter a valid user code. The ability to perform an operation is defined by your user code's authorization level. These authorization levels are pre-defined for each code as explained below.

#### Code 1: Master Code

The Master code is the highest user authorization level. With the Master code, you can edit all other user codes except the Installer code, the Guard code and the Central Station TWA Code. Additionally, the Master code grants access to the Event Log, the Service menu and Home Automation Schedule programming.



*The default Master code is 1234. Change this code immediately after installing the system!*

#### Codes 2-19: Controlled Codes

When you use a controlled user code for arming and disarming, the panel notifies the central station with an Arm/Disarm event message.

#### Codes 20-25: Non-controlled Codes

Non-controlled codes do not cause the panel to send Arm/Disarm event messages to the central station. The panel sends a Disarm message only if you use this code to disarm the system after an alarm occurrence.

#### Codes 26-27: Limited Codes

A Limited code enables the user to issue a code that is valid for one day only. This code automatically expires 24 hours after it has been programmed.

#### Code 28: Duress Code

The Duress code is designed for situations where the user is being forced to operate the system. This user code grants access to the selected operation, while sending a Duress event message to the central station.

### **Code 29: User TWA Code**

The User TWA code is designed to enable the user to establish Two-Way Audio communication with the control panel at any time. This code can only be used for this specific purpose and does not grant access to any additional system functions such as disarming.

### **Code 30: Central Station TWA Code**

The Central Station TWA code is designed to enable the central station operator to establish Two-Way Audio communication with the control panel after an alarm. This code is valid for use for the first ten minutes after an alarm has occurred. This code can only be used for this specific purpose and does not grant access to any additional system functions such as disarming.

### **Code 31: Guard Code (for future use)**

The Guard Code is a future option that is not available in the current firmware.

### **Code 32: Installer Code**

The Installer code grants access to the Programming menu and the Service menu. Additionally, this code enables you to view and clear the Event Log.



*The default Installer code is 1111. Change this code immediately after installing the system!*

#### **4.4.1: Editing User Codes**

To edit a user code:

1. From the main menu select, User Codes [4].
2. Select the code you want to edit.
3. From the code's sub-menu, select Edit Code [#1]; the 4-digit code is displayed with the cursor flashing on the first digit.
4. Edit the code.
5. Press ✓ ; the new code is stored in the memory.



*If you enter a code that is identical to an existing user code, the panel sounds an error tone and the new code is not accepted.*

*Codes 1-30 can be edited only by the Master code. The Installer code and the Central Station TWA Code can be edited only by the installer.*

#### **4.4.2: Deleting User Codes**

To delete a user code:

1. From the main menu select, User Codes [4].
2. Select the code you want to delete.
3. From the code's sub-menu, select Edit Code [#1]; the 4-digit code is displayed with the cursor flashing on the first digit.
4. Enter 0000.
5. Press ✓ ; the code is deleted.



*The Installer and Master codes cannot be deleted.*

### 4.4.3: User Code Descriptors

Each user code can be assigned a 16-character descriptor.

To edit a code descriptor:

1. From the main menu, select User Codes [4].
2. Select a code.
3. From the code's sub-menu, select Descriptor [#2].
4. Edit the descriptor using the alphanumeric keypad.
5. Press ✓ when you have finished editing.

### 4.5: Follow Me

The Follow Me feature is designed to notify the user that certain events have occurred.

To edit the Follow Me number:

1. From the main menu, select Follow Me [5].
2. Enter a telephone number for Follow Me communication. If using the SMS Follow Me feature, this number must be for a cellular phone with the capability to receive SMS messages.



*You may only access Follow Me programming if the protocol for Account 3 is programmed as SMS or TWA Follow Me.*

### 4.6: Event Log

The event log records the last 256 events the system has undergone. The log uses the FIFO (First In, First Out) method, automatically erasing the oldest event when the log is full.

To view the event log:

1. From the Event Log menu, select View Log [61]; a summarized version of the most recent event is displayed. Press the ⓪ key to view the time/date stamp or the device/user number on the second row of the display.
2. Use the arrow keys to scroll through the events.
3. When you have finished viewing, press X to exit the log.

The event log displays the following information for each event:

- The event descriptor – a brief description of the event that occurred.
- The zone where the event occurred.
- Time/date stamp – the exact time the event occurred.
- Report details – a single character indicating whether the event was reported to the central station. The options available are **R**: Report Sent, **F**: Report Failed or **N**: No Report.



- ① Event Descriptor
- ② Time/Date Stamp
- ③ Report Details

Figure 4.2: Detailed Event Log Display

Figure 4.2 shows the detailed event log entry for a Fire alarm on November 14<sup>th</sup> 2001. The event was successfully reported to the central station.



#### **4.6.1: Event Log Authorization Levels**

Every event that occurs is recorded in the event log. However, certain events are intended for the installer only. Those events include various service messages that are of little interest to the regular user. The View Log function requires you to enter either the Master or Installer code. The events that are displayed depend on which code you use to enter the log.

#### **4.6.2: Clearing the Event Log**

The Clear Log function erases all events from the log. After performing this function, a Clear Log event is recorded in the log. The Clear Log function is accessible using the Installer code only.

To clear the event log:

1. From the Event Log menu, select Clear Log [62]; the **OK?** confirmation message is displayed.
2. Press ✓ ; the log is cleared.

### **4.7: Service Menu**

The Service menu is accessible using either the Installer or Master code. This menu includes various functions that enable you to test system effectively.

#### **4.7.1: Set Time & Date**

The time and date are used to time stamp events in the event log. Additionally the time is also displayed on the LCD display in 24hr format.

To set the time:

1. From the Service menu, select Set Time/Date, Set Time [711].
2. Enter the current time in 24hr format.
3. Press ✓ ; the time is modified.

To set the date:

1. From the Service menu, select Set Time/Date, Set Date [712].
2. Enter the current date in DD/MM/YY format.
3. Press ✓ ; the date is modified

#### **4.7.2: External Siren Test**

To test the external siren:

- From the Service menu, select Ext. Siren Test [72]; the external siren is sounded briefly.

#### **4.7.3: Internal Siren Test**

To test the internal siren:

- From the Service menu, select Int. Siren Test [73]; the internal siren is sounded briefly.

#### **4.7.4: Speaker Test**

To perform a Speaker test:

- From the Service menu, select Speaker Test [74]; a short sequence of chimes are sounded from the speaker.

### 4.7.5: Walk Test

To initiate Walk Test mode:

1. From the Service menu, select Walk Test [75]; a list of registered sensors appears.
2. Trigger each sensor; when the system receives a successful transmission from a sensor, the sensor is removed from the list.
3. When all the sensors are removed from the list, **End Walk Test** is displayed.
4. Press **X** to exit Walk Test mode.

### 4.7.6: Transmitters

The Transmitters menu offers two utilities that serve as a valuable aid during installation. The first utility, TX List, is a scrollable inventory of all registered transmitters and their last reported status.

To view the TX list:

1. From the Service menu, select Transmitters, TX List [761]; the first transmitter on the list is displayed.
2. Using the arrow buttons, scroll through the transmitter list.
3. When you have finished viewing, press **X** to exit the list.

The TX list displays the following information for each transmitter:

- The transmitter’s descriptor.
- The signal strength of the last received transmission.
- An abbreviation indicating the last received status of the transmitter – see *Table 4.1*.

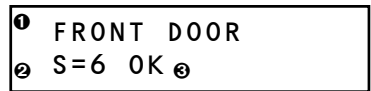

- ❶ Descriptor
- ❷ Signal Strength
- ❸ Status

Figure 4.3: TX List Display

This...	Means...
OK	The transmitter is functioning correctly
TA	Tamper condition
BT	Battery low
OS	The transmitter is out of synchronization
NA	The transmitter is inactive – see section 7.4: Supervision Time

Table 4.1: Transmitter Status Abbreviations



*In most cases, an “out of synchronization” condition indicates that an unauthorized attempt at grabbing the transmission has occurred – i.e. a previous transmission has been recorded and sent by somebody trying to violate the system.*

The second utility, TX Test, enables you to identify transmitters and test their signal strength.

In TX Test mode, each time a transmission is received, the activated transmitter is displayed.

If you enter this function using the Master code, a chime is sounded every time a transmission is received. If you enter this function using the Installer code, a sequence of tones are sounded indicating the transmitter's signal strength – see *Table 4.2*. This feature helps you to determine the best location to install a transmitter.

Signal Strength	Tones
0-2	1 Tone
3-5	2 Tones
6-8	3 Tones
8-9	4 Tones

**Table 4.2: Signal Strength Tones**

To initiate TX Test mode:

1. From the Service menu, select Transmitters, TX Test [762].
2. Activate a transmitter; the transmitter's details are displayed.
3. When you have finished, press **X** to exit TX Test mode.

#### 4.7.7: Audio Volume

To adjust the sensitivity of the microphone and the volume of the speaker:

1. Establish a two-way audio connection.
2. From the Service menu, select Audio Volume [77].
3. Adjust the setting according to the following table.

Press...	To...
1	Increase microphone sensitivity
4	Reduce microphone sensitivity
3	Increase speaker volume
6	Reduce speaker volume

**Table 4.3: Voice Level Adjustment**

4. Press **✓**; the new settings are stored in the memory.

#### 4.7.8: GSM Signal Strength

You can measure the GSM signal strength using the system's RSSI (Received Signal Strength Indication) meter. This function enables you to calculate the optimal location to install the control panel with the Cellular Communications module.

To view the GSM signal strength reading:

- From the Service menu, select GSM Signal [78]; the signal strength of the cellular network is displayed.

This Reading...	Means...
8 to 9	The location is good
5 to 7	The location is acceptable
Less than 5	Unacceptable – <i>choose another location!</i>

**Table 4.4: GSM Signal Strength**

#### 4.7.9: Display Version

To display the system's software and hardware versions.

- From the Service menu, select Version [79]; the hardware (HW) and software (SW) versions are displayed.

# Chapter Five: Two-Way Audio

---

The *infinite* control panel offers a range of Two-Way Audio features that can be used for applications such as alarm verification and medical assistance. This chapter explains these features, their operation procedures and programmable options.

Two-Way Audio communication can be separated into two fundamental groups; incoming and outgoing calls. These groups differ in their associated audio features.

## 5.1: Incoming Calls

The control panel can receive incoming calls from either the user or central station operator. Users may use this feature as a convenient way of contacting their family or to check their home when they are away. Additionally, the monitoring service can contact the user in the event of an emergency or use this feature for listen-in alarm verification.

For any of the incoming Two-Way Audio features to function, Incoming TWA must be enabled in the Communication Options section of the Programming menu.

### 5.1.1: User Code Verification

To prevent unauthorized attempts to connect with the control panel, there are two user codes designed for use with the Two-Way Audio feature. The User TWA code enables the user to establish Two-Way Audio communication at any time. The Central Station TWA Code is only valid for a ten-minute period following an alarm.

### 5.1.2: Incoming Calls via PSTN

In the case of PSTN communication, the control panel often shares a line with regular telephone handsets, an answering machine or a fax machine. It is therefore important that the control panel distinguish between calls so that it knows when to pick up the relevant call. For this purpose the *infinite* employs a double call method.

To connect to the control panel using the double call method:

1. Dial the telephone number of the line connected to the control panel.
2. Wait for two or three rings and hang-up.
3. Wait at least five seconds and dial the number again; on the second ring, the control panel picks up and sounds two DTMF tones.

### 5.1.3: Incoming Calls via a Cellular Network

The Cellular Communications Module has its own individual telephone number and therefore, the double call method is not needed. In this case, the user or central station operator may call the control panel directly.

### 5.1.4: Two-Way Audio Call Procedure

The following procedure explains how to make a Two-Way Audio call. The conditions and procedure differ when using PSTN or Cellular communication. For further information, read sections 5.1.1, 5.1.2, and 5.1.3 above.

To make a Two-Way Audio call:

1. Call the control panel either using the double call method (PSTN) or directly (Cellular); when the control panel picks up, two DTMF tones are sounded.
2. Enter the User TWA or Central Station TWA code on your telephone within 15 seconds.



*Do not enter your user code until you hear the two DTMF tones. Any digits entered before the tones are sounded are disregarded by the system.*

3. The duration of the call is determined by the TWA Timeout. Ten seconds before the timeout expires, two short DTMF tones are sounded. To extend the call, press 7 on your telephone. This command restarts the timeout.
4. To disconnect before the end of the timeout, press “\*” then “#” on your telephone.

### 5.1.5: Siren Muting

The siren is muted during Two-Way Audio communication. At the end of the call, the siren is re-activated (if the Siren Cut-Off has not yet expired). You can cancel the re-activation of the siren by pressing “9” on your telephone during the call.

## 5.2: Outgoing Calls

The *infinite* control panel can make Two-Way Audio calls to the user or central station in the event of an alarm. This feature is designed for applications such as alarm verification, panic and medical emergency.

### 5.2.1: Service Call

The Service Call feature enables the user to establish a two-way audio connection with the central station operator. For further information on how to program this feature, see section 10.4: Service Call.



Figure 5.1:  
Service Call Key

To initiate a Service Call:

- Press and hold down the Service Call key for a few seconds.

### 5.2.2: TWA Alarm Reporting

In the event of Burglary, Fire and Medical alarms, the control panel is able to report the events and then stay on the line after ACK 2 is received. This allows the operator to verify the alarm or provide assistance in the event of an emergency.

For this feature to function, you must enable Two-Way Audio for both the account and the event group.

The sequence for Two-Way Audio during alarm reporting is as follows:

1. An alarm event is sent to the central station and acknowledgment is received (ACK 2).
2. If Two-Way Audio is enabled for the account and event group, the control panel stays on the line and opens the audio channel.
3. The duration of the call is determined by the TWA Timeout. Ten seconds before the timeout expires, two short DTMF tones are sounded. To extend the call, press 7 on your telephone. This command restarts the timeout.
4. To disconnect before the end of the timeout, press “\*” then “#” on your telephone.

If multiple events are sent, the control panel sends all the events before opening the audio channel.



*When using the SIA protocol for event reporting, this feature functions in “listen-in” mode only.*

### 5.2.3: TWA Follow-Me

The TWA Follow-Me feature is designed to establish a Two-Way Audio connection with the user in the event of an alarm. For this feature to function, the account's protocol must be defined as TWA Follow-Me.

The sequence for a Two-Way Audio Follow-me call is as follows:

1. An alarm occurs.
2. The control panel dials the user's telephone number and sounds two DTMF tones when you pick up the call.
3. Press any key on the telephone; the control panel opens the audio channel.



*If you press 9 to answer the call, the control panel simultaneously cancels the siren when opening the audio channel.*

4. The duration of the call is determined by the TWA Timeout. Ten seconds before the timeout expires, two short DTMF tones are sounded. To extend the call, press 7 on your telephone. This command restarts the timeout.
5. To disconnect before the end of the timeout, press "\*" then "#" on your telephone.

# Chapter Six: Home Automation Control

The purpose of this chapter is to explain the various methods used to control X10 Home Automation (HA) units installed around the home. For further information on the X10 protocol and the choice of options that are available in programming, see Chapter Eleven: Home Automation Programming.

## 6.1: Keypad Control

Using either the LCD or the wireless keypad, you can control HA units with the dedicated Home Automation keys – see *Figure 6.1*.

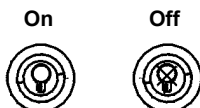

Figure 6.1: LCD Keypad Home Automation Keys

To control HA units via the LCD keypad:

1. Press one of the two Home Automation keys on the keypad (On or Off).
2. Enter the number of the required HA unit in two-digits (01-16); the command is sent to the HA unit

## 6.2: Keyfob Control

You can control up to two different HA units using any of the four button keyfobs registered to the system. For further information on how to assign keyfob buttons to HA units, see section 7.7.2: Button Assignment.

## 6.3: SMS Control

You can send On and Off commands to HA units using SMS messages sent from a cellular phone to the cellular communications module. For this feature to function correctly, SMS control must be enabled for the specific HA units you want to control – see section 11.2.5: SMS Control.

### 6.3.1: SMS Command Format

Each SMS command contains the following elements:

- ① SMS Command Descriptor (up to 43 characters of free text)
- ② # (delimiter – separates the descriptor from the actual command)
- ③ User Code (4 digits)
- ④ Command (0=Off, 1=On)
- ⑤ Device Number (HA Units: 01-16)

The following example shows the format of an SMS command to switch on a water boiler controlled by HA unit 8.

①					②	③				④	⑤					
B	o	i	l	e	r		O	n	#	1	2	3	4	1	0	8



While the SMS Command Descriptor is optional, you must start the SMS command with the # symbol for the system to accept the command.

### 6.3.2: SMS Confirmation Message Format

After an SMS command is executed by the system, a message is returned to the sender – see 11.4: *SMS Confirmation*. This message includes the HA unit’s descriptor and the command that was sent.

The following example shows the confirmation message the sender receives for the sample command from the previous section.

B	o	i	l	e	r	-	O	N
---	---	---	---	---	---	---	---	---

## 6.4: Scheduling

Scheduling allows you to program the panel to send On/Off commands to HA units at specific times. You can also program the days of the week that the schedule is active.

### 6.4.1: On Time

To edit an HA unit’s “On” Time:

1. From the main menu, select HA Schedules [8].
2. Select an HA unit.
3. From the X10 unit’s sub-menu, select On Time [#1].
4. Enter a time (HH:MM).
5. Press ✓ when the desired setting is displayed.

### 6.4.2: Off Time

To edit an HA unit’s “Off” Time:

1. From the main menu, select HA Schedules [8].
2. Select an HA unit.
3. From the HA unit’s sub-menu, select Off Time [#2].
4. Enter a time (HH:MM).
5. Press ✓ when the desired setting is displayed.

### 6.4.3: Weekly Schedule

To program the days of the week that the schedule is active:

1. From the main menu, select HA Schedules [8].
2. Select an HA unit.
3. From the HA unit’s sub-menu, select Schedule [#3].
4. Use keys 1 to 7 to toggle the days on and off.

Press...	To toggle...
1	Sunday
2	Monday
3	Tuesday
4	Wednesday
5	Thursday
6	Friday
7	Saturday

Table 6.1: Weekly Schedule

5. Press ✓ when the desired setting is displayed.



# Chapter Seven: Devices

This chapter explains how to register devices to the system and the programming options for each device. For further information, please refer to the installation instructions included with each device.

## 7.1: Device Registration

For the system to recognize individual devices, each device must be registered to the system. For example, if the device is a wireless transmitter, registration enables the system to identify the source of a received transmission. Each device has an individual encrypted ID code. Registering the device to the system familiarizes the system with this code.



*It is not necessary to register hardwire sensors connected to Zone 33.*

To register a device to the system:

1. From the Programming menu, select Devices [91].
2. Select the type of transmitter you want to register. For example, if you want to register a wireless sensor to a zone, select Zones.
3. Select the specific device you want to register (for example, Zone 4); the system initiates Registration mode. During Registration mode, the system waits for two transmissions from the device.



*If a device has already been registered at the required location, the system will not initiate Registration mode. If the device has already been registered at another location, attempts to register are ignored by the system*

4. Register the device – refer to each device's installation instructions in Appendix B for further details.
5. When two transmissions have been received, **Save?** is displayed.
6. Press **✓** to confirm registration, or **X** to cancel.

## 7.2: Device Descriptors

You can assign a 16-character descriptor to each device except the siren. These descriptors help identify the devices when you operate and program the system.

To edit a device descriptor:

1. From the Programming menu, select Devices [91].
2. Select a device type.
3. From the device's sub-menu, select Descriptor.
4. Edit the descriptor using the alphanumeric keypad.
5. Press **✓** when you have finished editing.

### **7.3: Device Deletion**

When you want to remove a device from the system, you have to delete the device. It is important to delete unused devices for two reasons. Firstly, you have to delete a device before you can register a new transmitter in its place. Secondly, if the device is a wireless sensor, it is important to delete the device so that the system will not react to the transmitter's failure to send supervision signals.

To delete a device:

1. From the Programming menu, select Devices, [91].
2. Select the type of wireless device you want to delete.
3. From the device's sub-menu, select Delete.
4. Press ✓ to confirm; the device is deleted.

### **7.4: Supervision Time**

The sensors in Electronics Line 3000's supervised wireless range send a supervision signal approximately one hour after its last transmission. If the system does not receive supervision signals from a specific transmitter, the transmitter is regarded as inactive.

The amount of time after which a transmitter is considered inactive is called the Supervision Time.

To program the Supervision Time:

1. From the Programming menu, select Devices, Superv. Time [916].
2. Enter the Inactive Time between 4:00 and 8:59 hours.

### **7.5: Re-Synchronization**

Transmissions that are out of synchronization are rejected by the system. For example, it is not possible to arm or disarm the system using a keyfob that is out of synchronization. In the event that a transmitter is out of synchronization, it is possible to re-synchronize the transmitter and restore normal operation.

To re-synchronize transmitters:

1. From the Programming menu, select Devices, TX Re-synch [917]; a 10-minute time window is opened.
2. During the 10-minute time window, if a transmission is received that is out of synchronization, the transmitter is re-synchronized.

### **7.6: Zones**

The *infinite* includes 33 security zones. Zones 1-32 are intended for wireless sensors. One sensor can be registered to each wireless zone. The system supports Electronics Line 3000's supervised wireless range of transmitters that includes various PIR sensors, magnetic contacts and smoke detectors. All these transmitters send supervision signals to the panel's receiver in order to indicate that the transmitter is functional.

Zone 33 is an on-board hardwire zone. This zone is programmed in the same way as the wireless zones with the exception of registration and deletion – *this feature is not supported by all firmware versions.*

This section explains the sections of programming exclusive to sensors. For information on registration, descriptor editing and deletion, see sections 7.1, 7.2 and 7.3, respectively.

## 7.6.1: Zone Type

The zone type defines the type of alarm the system generates when the sensor is tripped.

To program a zone type:

1. From the Programming menu, select Devices, Zones [911].
2. Select the sensor you want to program.
3. From the sensor's sub-menu, select Zone Type [#2].
4. Select a zone type from Table 7.1.

Zone Type	Description
Normal	When the system is armed, this zone instantly generates an alarm when triggered.
Entry/Exit	When the system is armed, this zone initiates the entry delay when triggered. If the system is not disarmed by the time the entry delay expires, an alarm is generated.
Follower	If an Entry/Exit zone is triggered first, Follower zones do not generate an alarm when triggered during the entry delay. If the system is not disarmed by the end of the entry delay, the Follower zone generates an alarm. A Follower zone instantly generates an alarm if the entry delay is not active.
Panic	Panic zones are always active, regardless of whether the system is armed or not. When a Panic zone is triggered, a Panic alarm is generated.
Medical	Medical zones are always active. When triggered, these zones generate a Medical alarm.
Fire	These zones are always active. When a fire sensor is triggered, the zone generates a Fire alarm.
24Hr	This zone type produces a burglary alarm when triggered, even when the system is disarmed.
24Hr-X (future use)	The 24Hr-X zone is a future option that is not available in the current firmware.
Not Used	This zone type disables the sensor output. All alarm transmissions from the sensor are ignored though the sensor may still be used to activate HA units in Home Automation applications.

Table 7.1: Zone Type Options

## 7.6.2: Arm Set

The Arm Set option allows you to define the arming methods in which the zone is included.

To program the Arm Set option:

1. From the Programming menu, select Devices, Zones [911].
2. Select the sensor you want to program.
3. From the zone's sub-menu, select Arm Set [#3]; the zone's current Arm Set setting is displayed.

Arm Set	Description
1 (F)	The zone is included in Full arming.
2 (P)	The zone is included in Part arming.
3 (PE)	The zone is included in Perimeter arming.

Table 7.2: Arm Set Options

4. Use the keys 1, 2 and 3 to toggle the current setting.
5. Press ✓ when the desired setting is displayed.



*It is not necessary to program this option for Panic, Medical, Fire and 24Hr zones.*

### 7.6.3: Bell

Each zone can be programmed to activate the siren when triggered or to generate a silent alarm where only a message is sent to the central station.

To program the Bell option:

1. From the Programming menu, select Devices, Zones [911].
2. Select the zone you want to program.
3. From the zone's sub-menu, select Bell [#5]; the zone's current Bell setting is displayed.
4. Select either Enable or Disable.



*Fire zones always activate the siren regardless of what is programmed for this option.*

*If the bell is disabled for Panic zones, this also disables all forms of alarm indication from the on-board keypad in the event of a Panic alarm.*

### 7.6.4: Chime

When Chime is enabled, triggering the zone when the system is disarmed causes the internal siren to chime.

To program the Chime option:

1. From the Programming menu, select Devices, Sensors [911].
2. Select the zone you want to program.
3. From the zone's sub-menu, select Chime [#6]; the zone's current Chime setting is displayed.
4. Select either Enable or Disable.

### 7.6.5: Force Arm

Force arming enables you to arm the system when the system is not ready. For example, a door that is protected by a magnetic contact is open. You may arm the system on condition that the zone is defined as Force Arm enabled. This door must be closed by the end of the Exit delay otherwise an alarm is generated. If the magnetic contact's zone is defined as Force Arm disabled, the system will not be ready to arm until you close the door.

To program the Force Arm option:

1. From the Programming menu, select Devices, Zones [911].
2. Select the zone you want to program.
3. From the zone's sub-menu, select Force Arm [#7]; the zone's current Force Arm setting is displayed.
4. Select either Enable or Disable



*For the Force Arm feature to function, you must also enable Force Arming in the System options (see 9.3: Forced Arm).*

### 7.6.6: Swinger

A zone defined as Swinger enabled can generate only a limited number of alarms during a specific time period. The Swinger setting is defined in System Options.

To program the Swinger option:

1. From the Programming menu, select Devices, Zones [911].
2. Select the zone you want to program.
3. From the zone's sub-menu, select Swinger [#8]; the zone's current Swinger setting is displayed.
4. Select either Enable or Disable.



Do not enable the Swinger option for zones that are always active (Panic, Medical, Fire and 24-hr zones).

## 7.7: Keyfobs

The *infinite* supports two types of keyfob transmitter, EL-2611 and EL-2614. You can register up to eight keyfobs to the system. Figure 7.1 illustrates these transmitters and the functions assigned to their buttons. For information on registration, descriptor editing and deletion, see sections 7.1, 7.2 and 7.3, respectively.

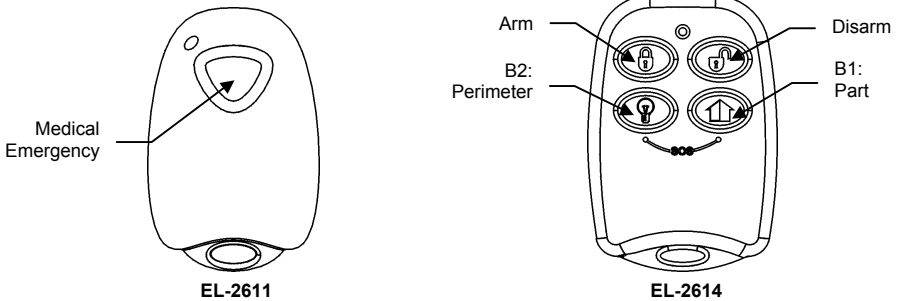

Figure 7.1: Keyfob Button Assignments

The following sections explain the programming options exclusive to the EL-2614 keyfob transmitter. These programming options are not relevant to the EL-2611.

### 7.7.1: Keyfob Type

You can define each registered keyfob as Controlled or Non-controlled. A Controlled keyfob causes the system to send arm/disarm event messages to the central station. Non-controlled keyfobs never send arm messages and send a disarm message only if the system is disarmed after an alarm occurrence.

To program a keyfob type:

1. From the Programming menu, select Devices, Keyfobs [912].
2. Select the keyfob you want to program.
3. From the keyfob's sub-menu, select Type [#2]; the current setting is displayed.
4. Select either Controlled or Non-controlled.

### 7.7.2: Button Assignment

The EL-2614 includes two buttons (B1 and B2) that you can program individually. The default functions for B1 and B2 offer different arming methods. Alternatively, you can program these buttons to control a specific HA unit.

To program buttons B1 and B2:

1. From the Programming menu, select Devices, Keyfobs [912].
2. Select the keyfob you want to program.
3. From the keyfob's sub-menu, select either B1 Assign [#4] or B2 Assign [#5].
4. Select the HA unit you want the button to control (01-16) or enter 00 to program the button's default function.

The default functions are as follows:

B1: Part arming

B2: Perimeter arming

### 7.7.3: SOS Panic Alarm Activation (EL-2614)

Using the four-button keyfob, you can activate an SOS Panic alarm by pressing two buttons simultaneously. Figure 7.2 illustrates how to activate an SOS Panic alarm on the EL-2614 wireless keyfob.

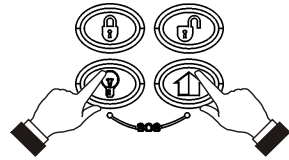

Figure 7.2: SOS Panic Alarm Activation

## 7.8: Smartkeys (for future use)

Smartkeys enable the user to arm and disarm the system without needing to enter a code. You can register up to 16 smartkeys to the system. For information on registration, descriptor editing and deletion, see sections 7.1, 7.2 and 7.3, respectively.

### 7.8.1: Smartkey Type

You can define each registered smartkey as Controlled or Non-controlled. A Controlled smartkey causes the system to send arm/disarm event messages to the central station. Non-controlled smartkeys never send arm messages and send a disarm message only if the system is disarmed after an alarm occurrence.

To program the smartkey type:

1. From the Programming menu, select Devices, Smartkeys [913].
2. Select the smartkey you want to program.
3. From the smartkey's sub-menu, select Type [#2]; the current setting is displayed.
4. Select either Controlled or Non-controlled.

## 7.9: Keypads

Up to four wireless keypads are supported by the system. With the exception of the Cancel key, operation is identical for both EL-2620 and EL-2640 keypads. For information on registration, descriptor editing and deletion, see sections 7.1, 7.2 and 7.3, respectively.

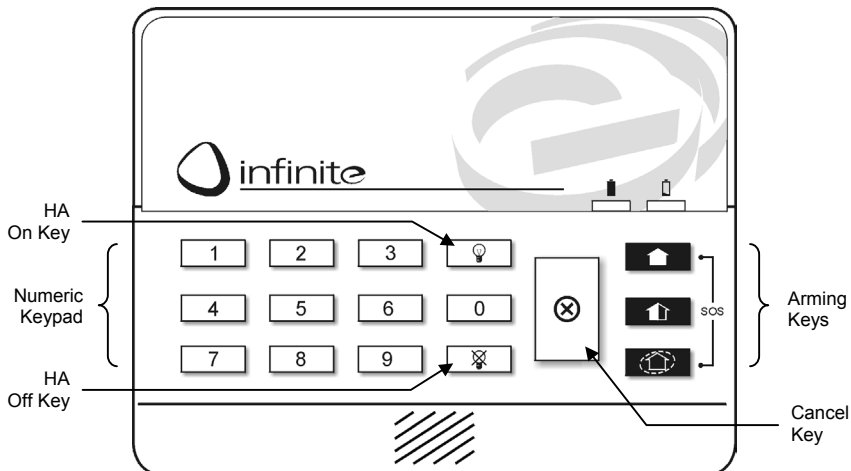

Figure 7.3: EL-2620 Keypad Layout

### 7.9.1: Keypad SOS Panic Alarm Activation

Using any of the wireless keypads, you can activate an SOS Panic alarm by pressing the Full and Perimeter arming keys simultaneously. Figure 7.4 illustrates how to activate an SOS Panic alarm on the EL-2620 wireless keypad.

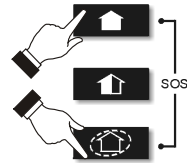

Figure 7.4: SOS Panic Alarm Activation (EL-2620)

## 7.10: External Siren

The control panel may include an optional on-board transmitter that sends alarm and arm status information to the wireless siren's receiver. This transmitter must be registered to the siren's receiver.

To register the on-board transmitter to the siren's receiver:

1. Set the siren's receiver to Registration mode – *refer to the siren's installation instructions for further information.*
2. Activate the siren using the External Siren Test feature – *see 4.7.2: External Siren Test.*
3. Activate the siren again; the on-board transmitter is registered to the siren's receiver.

When installing 2-way sirens, the siren also includes a transmitter that must be registered to the system. For information on registration and deletion, see sections 7.1 and 7.3, respectively.

### 7.10.1: Siren Type

The control panel supports both 1-way and 2-way sirens. For this feature to function correctly, you must define the siren type in programming.

To program the siren type:

1. From the Programming menu, select Devices, Siren, Ext. Siren Type [9152].
2. Select a siren type or No Ext. Siren if no siren is installed.

### 7.10.2: Siren Delay

The Siren Delay is the period of time during which the external siren is not sounded after an alarm is triggered by normal, follower or 24Hr zones. This feature is implemented only when the system is not fully armed. During the Siren Delay, only the internal siren is sounded and an alarm report is not sent until the delay has expired. This gives the user enough time to disarm in the event that the alarm was accidentally triggered during Part or Perimeter arming. If the user disarms the system during the Siren Delay, an event message is not sent to the central station.

To program the Siren Delay time:

1. From the Programming menu, select Devices, Siren, Siren Delay [9153].
2. Enter a Siren Delay time (000-063 seconds).
3. Press ✓ when the desired setting is displayed.

### 7.10.3: Siren Cut-Off

The Siren Cut-Off is the period of time the siren is activated after an alarm has occurred.

To program the Siren Cut-Off time:

1. From the Programming menu, select Devices, Siren, Cut-Off [9154].
2. Enter a Siren Cut-Off time (001-254 seconds).
3. Press ✓ when the desired setting is displayed.

#### **7.10.4: Wireless Sounder Module (firmware versions 2.01 and above)**

The infinite-WSM (Wireless Sounder Module) is a peripheral module that provides the infinite control panel with a wireless interface to most popular sirens and sounders. This module is supported in firmware versions 2.01 and above.

To support the infinite-WSM, define the siren type as 1-Way siren. You may program a Siren Cut-Off time of between 001-254 seconds. If you wish to use the siren's internal cut-off timer, program the Siren Cut-Off as 255 (continuous).



*If the Siren Cut-Off is programmed as 255 (continuous), the external siren will continue to sound until its internal cut-off time expires. In this case, the control panel's internal siren will sound for 255 seconds.*



## Chapter Eight: Entry/Exit Timers and Arming Tones

---

This chapter explains how to program the time of the Entry/Exit delays and the tones sounded by the two sirens during Exit/Entry delays, arming and disarming.

### **8.1: Entry/Exit Delay**

The Entry/Exit delay timers determine the amount of time the user has to arm or disarm the system before an alarm is activated. When these timers count down, the internal siren sounds a series of tones throughout the delay.

You can program separate Entry and Exit delays for each arming method.

To program Exit delay timers:

1. From the Programming menu, select Entry/Exit, Exit Delays [921].
2. Select the Exit delay you want to program: Full [#1], Part [#2] or Perimeter [#3].
3. Enter a delay time (000-255 seconds).
4. Press ✓ when the desired setting is displayed.

To program Entry delay timers:

1. From the Programming menu, select Entry/Exit, Entry Delays [922].
2. Select the Entry delay you want to program: Full [#1], Part [#2] or Perimeter [#3].
3. Enter a delay time (000-255 seconds).
4. Press ✓ when the desired setting is displayed.

### **8.2: Arm on Exit**

The Arm on Exit feature cancels the unnecessary remainder of the Exit delay that continues to count down after the user has vacated the premises. This feature automatically arms the system when an Entry/Exit zone is closed during the Exit delay.

To program the Arm on Exit option:

1. From the Programming menu, select Entry/Exit, Arm On Exit [923].
2. Select Enable or Disable

### **8.3: Arming Tones**

Arming tones are the tones sounded by either from the internal or external sirens when arming and disarming the system. Each set of tones can be enabled or disabled according to the requirements of the installation.

#### **8.3.1: Exit Delay Tones**

To program external siren tones during the Exit delay:

1. From the Programming menu, select Tones, Exit Tones, External Tones [9311].
2. Select Enable or Disable.

To program internal siren tones during the Exit delay:

1. From the Programming menu, select Tones, Exit Tones, Internal Tones [9312].
2. Select No Tones, Four Tones or Continuous Tones.

### **8.3.2: Entry Delay Tones**

To program external siren tones during the Entry delay:

1. From the Programming menu, select Tones, Entry Tones, External Tones [9321].
2. Select Enable or Disable.

To program internal siren tones during the Entry delay:

1. From the Programming menu, select Tones, Entry Tones, Internal Tones [9322].
2. Select No Tones, Four Tones or Continuous Tones.

### **8.3.3: Arming Tones**

To program external siren tones on arming:

1. From the Programming menu, select Tones, Arm Tones, External Tones [9331].
2. Select Enable or Disable.

To program internal siren tones on arming:

1. From the Programming menu, select Tones, Arm Tones, Internal Tones [9332].
2. Select Enable or Disable.

### **8.3.4: Disarming Tones**

To program external siren tones on disarming:

1. From the Programming menu, select Tones, Disarm Tones, External Tones [9341].
2. Select Enable or Disable.

To program internal siren tones on disarming:

1. From the Programming menu, select Tones, Disarm Tones, Internal Tones [9342].
2. Select Enable or Disable.

### **8.3.5: Home Automation Tones**

Home Automation tones are sounded when you control HA units using keypads or keyfob transmitters.

To program internal siren Home Automation tones:

1. From the Programming menu, select Tones, HA Tones [935].
2. Select Enable or Disable.

## Chapter Nine: System Options

---

As the name suggests, System Options are settings that affect the entire system. This chapter offers explanations and programming instructions for each of these options.

### 9.1: Swinger Setting

A sensor defined as Swinger enabled can generate only a limited number of alarms during a specific time period or during an arming period. The following options are available:

- One alarm per arming period
- One alarm per hour
- One alarm per day
- One alarm per week

To program the Swinger setting:

1. From the Programming menu, select System Options, Swinger [9401].
2. Select a Swinger setting from the above list.

### 9.2: Code Lockout

The Code Lockout option locks the keypad for 30 minutes if five unsuccessful attempts are made to enter the user code.

To program the Code Lockout setting:

1. From the Programming menu, select System Options, Code Lockout [9402].
2. Select Enable or Disable.



*During the 30-minute lockout period, you can still arm and disarm the system using keyfobs and smartkeys. If one key arming is enabled, you may still arm the system using the wireless keypad.*

### 9.3: Forced Arm

Forced arming enables you to arm the system when the system is not ready. This option allows you to enable or disable Forced arming for the entire system. Additionally, you can enable or disable Forced arming for each individual zone. For further information, see section 7.6.5: Force Arm.

To program the Forced Arm setting:

1. From the Programming menu, select System Options, Forced Arm [9403].
2. Select Enable or Disable.

### 9.4: HA Control

The HA Control option allows you to enable or disable all Home Automation features for the entire system.

To program the Home Automation setting:

1. From the Programming menu, select System Options, HA Control [9404].
2. Select Enable or Disable.

## **9.5: Panic Alarm**

SOS Panic alarms generated from the front panel, keypads or keyfobs can be defined as either audible or silent.

To program the Panic Alarm setting:

1. From the Programming menu, select System Options, Panic Alarm [9405].
2. Select Audible or Silent.

## **9.6: One-Key Arming**

You can arm the system by pressing any of the three arming keys on the keypad. If One-Key Arming is enabled, the system does not prompt you for a user code.

To program the One-Key Arming setting:

1. From the Programming menu, select System Options, One-Key Arming [9406].
2. Select Enable or Disable.

## **9.7: Supplementary Entry Delay**

The Supplementary Entry Delay is a pre-alarm feature that is employed in the event that the system is not disarmed during the entry delay. When the entry delay expires, the internal siren is sounded during an additional entry delay period. At the end of the supplementary entry delay, the system generates a full alarm condition; the external siren is sounded and the central station is notified.

To program the Supplementary Entry Delay setting:

1. From the Programming menu, select System Options, Supp. Entry Delay [9407].
2. Select Enable or Disable.

## **9.8: Entry Deviation**

Entry Deviation is a pre-alarm feature employed in the event that a sensor defined with the "Normal" zone type is opened during the entry delay. In this case, the internal siren is sounded until the end of the entry delay period. Failure to disarm by the end of the entry delay causes the system to generate an alarm.

To program the Entry Deviation setting:

1. From the Programming menu, select System Options, Entry Deviation [9408].
2. Select Enable or Disable.

## 9.9: AC Loss Delay

The AC Loss Delay is the amount of time that has to elapse before an AC Loss report is sent to the central station. If AC power is restored before the event message is sent, the event message is cancelled and will not be sent. You can program an AC Loss Delay to be between 1 and 255 minutes after the system first senses the AC loss condition. Alternatively you can program a random AC Loss Delay.

The AC Restore message is also sent using the same method described above. AC Restore is reported only if the AC Loss report was sent.

To program the AC Loss Delay:

1. From the Programming menu, select System Options, AC Loss Delay [9409].
2. Enter a delay time (001-255 minutes) or enter 000 if you require the system to choose a random AC Loss Delay.
3. Press ✓ when the desired setting is displayed.

### 9.9.1: Random AC Loss Delay

In the event of AC loss, an event message is sent to the central station between 15 and 30 minutes after the AC loss condition is sensed. The system chooses this delay at random in order to prevent the central station being simultaneously inundated by AC Loss reports in the event of a regional power cut.

## 9.10: Arm Status Display

The Arm Status Display includes the current arm status and any trouble conditions that may exist within the system. You can program the system to display this information at all times or only for two minutes after arming or disarming the system.

To program the Arm Status Display options:

1. From the Programming menu, select System Options, Arm Status Display [9410].
2. Select Always or Display 2 Min.

### 9.11: Banner

The Banner is the 16-character text that you can program to appear on the top row of the LCD display. This text replaces the arm status if it is programmed to display for two minutes only – see 9.10: *Arm Status Display*.

To edit the Banner text:

1. From the Programming menu, select System Options, Banner [9411].
2. Edit the Banner text using the alphanumeric keypad.
3. Press ✓ when you have finished editing.



*The system never displays the Banner text if the Arm Status Display option is programmed as Always.*

## 9.12: PGM Output

The PGM is a programmable output that is triggered according to specific system status conditions.

### 9.12.1: Output Trigger

The Output Trigger option determines the conditions that activate and deactivate the PGM output.

To program the Output Trigger:

1. From the Programming menu, select System Options, PGM Options, Output Trigger [94121].
2. Select an Output Trigger option from the following table.

Trigger Option	Activated by...	Deactivated by...
PGM Not Used	The PGM output is disabled	
Full Arm	System "Full" armed	System disarmed or PGM Cut-off
Perimeter Arm	System "Perimeter" armed	
Part Arm	System "Part" armed	
Arm Status	Any arming method	
Power Trouble	AC Loss or Low Battery conditions	AC restore or Battery restore
Tel. Line Trouble	Telephone line supervision trouble	Telephone line restore
System Trouble	System trouble condition	System trouble restore
Medical	Medical alarm	Any arming method, system disarmed or PGM Cut-off
Burglary	Burglary alarm	
Fire Alarm	Fire alarm	
Zone Status*	Open zones (steady) Bypassed zones (pulsing)	All zones closed and no zones bypassed
Entry/Exit	Entry/Exit delay follower	
Internal Bell	Internal siren follower	

**Table 9.1: PGM Output Trigger Options**

\* Functions only when the system is disarmed.



*For certain trigger options, deactivation may be determined by the PGM Cut-off (see 9.12.4: PGM Cut-off). If the PGM Cut-off is programmed as 000 (continuous activation), the PGM output shall remain activated until it is toggled by the relevant change in system status.*

### 9.12.2: Output Type

The Output Type option determines whether the PGM output produces a steady or pulsed output.

To program the Output Type:

1. From the Programming menu, select System Options, PGM Options, Output Trigger [94122].
2. Select Steady or Pulsed.



*The Zone Status and Internal Bell trigger options have a fixed Output Type; there is no need to program an Output Type for these options.*

### **9.12.3: Polarity**

You can determine the polarity of the PGM output from the following two options:

- Active High: The output is normally off and is switched on when activated.
- Active Low: The output is normally on and is switched off when activated.

To program the Output Type:

1. From the Programming menu, select System Options, PGM Options, Polarity [94123].
2. Select Active High or Active Low.

### **9.12.4: PGM Cut-off**

The PGM Cut-off is the duration for which the PGM is activated. Certain Output Trigger types, are deactivated after the PGM Cut-off time has expired— see *Table 9.1: PGM Output Trigger Options*. For those Output Trigger types that are not affected by the PGM Cut-off, there is no need to program this option.

To program the PGM Cut-off time:

1. From the Programming menu, select System Options, PGM Options, PGM Cut-off [94124].
2. Enter a PGM Cut-off time (001-255 seconds or 000 for continuous activation).
3. Press ✓ when the desired setting is displayed.

### **9.13: Guard Code (for future use)**

The Guard Code is a future option that is not available in the current firmware. The default setting for this option is disabled. Electronics Line 3000 recommend that you do not change this setting.

# Chapter Ten: Communications

---



This section explains how to determine the way the control panel communicates via the GSM and PSTN modules.

## 10.1: Accounts

The control panel supports three customer accounts. Each account has its own telephone number and communications options. An explanation of each of these options is included in this section.

### 10.1.1: Telephone Number

To edit an account's telephone number:

1. From the Programming menu, select Communications, Accounts [951].
2. Select an account.
3. From the account's sub-menu, select Telephone # [#1].
4. Enter up to 16 digits. Use the  key to enter “,” (pause), “T” (switch to DTMF tone dialing), “P” (switch to pulse dialing) or “+” (international code). Use the  key to delete one character at a time.
5. Press  when you have finished editing.

### 10.1.2: Account Number

To edit an account number:

1. From the Programming menu, select Communications, Accounts [951].
2. Select an account.
3. From the account's sub-menu, select Account # [#2].
4. Enter up to eight digits. Enter leading zeros for account numbers of less than eight digits.
5. Press  when you have finished editing.

### 10.1.3: Protocol

To program an account's communication protocol:

1. From the Programming menu, select Communications, Accounts [951].
2. Select an account.
3. From the account's sub-menu, select Protocol [#3].
4. Select a protocol from the options available.



*Account number 3 is designed for use with the Follow me feature. It is the only telephone number that can be programmed by the user.*

### 10.1.4: Communication Interface

For each account, you can choose whether the system employs cellular or PSTN communication.

To program an account's communication interface:

1. From the Programming menu, select Communications, Accounts [951].
2. Select an account.
3. From the account's sub-menu, select Interface [#4].
4. Select either GSM or PSTN.



### 10.1.5: Call Attempts

The Call Attempts option determines the number of times the system tries to call a telephone number before moving on to the next number in sequence.

To program the number of call attempts for an account:

1. From the Programming menu, select Communications, Accounts [951].
2. Select an account.
3. From the account's sub-menu, select Call Attempts [#5].
4. Enter a value between 01 and 15.
5. Press ✓ when the desired setting is displayed.

### 10.1.6: Two-Way Audio

The Two-Way audio option determines whether Two-Way Audio is enabled for the account. For further information, see section 5.2.2: TWA Alarm Reporting.

To program the number of call attempts for an account:

1. From the Programming menu, select Communications, Accounts [951].
2. Select an account.
3. From the account's sub-menu, select TWA [#6].
4. Select Enable or Disable.

## 10.2: General Account Options

The options included in this section concern event reporting for all three accounts.

### 10.2.1: Call Continue

When reporting an event, the system attempts to call Telephone #1. If the system fails in its attempt to report the event, it dials Telephone #2 then Telephone #3, respectively. If the Call Continue feature is active, the control panel sends a duplicate report to the accounts that are selected. For example, using this feature, the system can send an alarm report to the central station then notify the user by sending an SMS message to their mobile phone.

To program the Call Continue option:

1. From the Programming menu, select Communications, Accounts, Call Continue [9514]; the current Call Continue setting is displayed.

Press...	To...
1	Toggle Account #1 in the Call Continue sequence.
2	Toggle Account #2 in the Call Continue sequence.
3	Toggle Account #3 in the Call Continue sequence.

Table 10.1: Call Continue Options

2. Use keys 1, 2 and 3 to toggle the account numbers.
3. Press ✓ when the desired setting is displayed.

### 10.2.2: Report Cycles

The system's attempts to report events are organized in cycles. A report cycle is a set of call attempts. If the system does not succeed in sending a report to any of the telephone numbers, it tries to dial the entire report cycle again until it sends a successful report. You can determine the number of times the system attempts to dial this sequence by programming the Report Cycle option.

To program the number of Report Cycles:

1. From the Programming menu, select Communications, Accounts, Report Cycles [9515].
2. Enter a value between 01 and 03.
3. Press ✓ when the desired setting is displayed.

In the example illustrated in Figure 10.1, Account 1 is programmed with 2 call attempts, Account 2 is programmed with 3 call attempts and the number of report cycles programmed is 3.

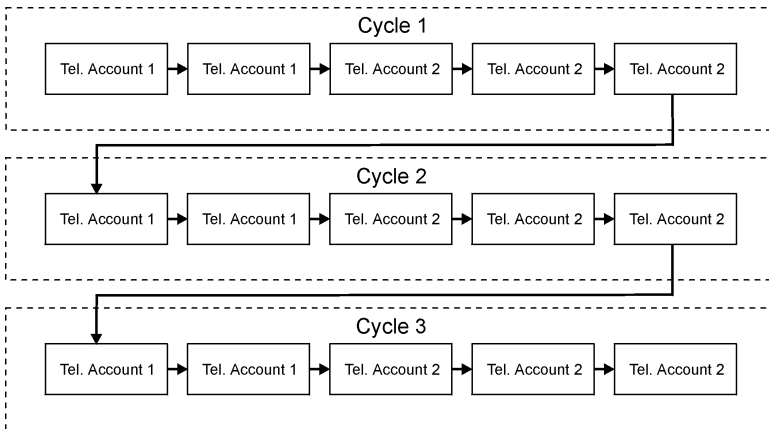

Figure 10.1: Typical Report Cycle Sequence

### 10.3: Remote Programming

Electronics Line 3000's Remote Programmer (RP) software enables you to operate and program the system from a PC either on-site or from a remote location. The software provides a comprehensive interface to the *infinite* control panel designed to facilitate programming.

You can connect to the panel from a PC using one of three methods:



- Direct Call: The RP calls the site, the system picks up and RP communication is established.
- Callback: The RP calls the site, the system picks up then hangs up. The system then calls the Callback telephone number to establish a connection.
- Serial Connection: The RP connects directly via the Main board's 9-pin serial port (this method requires that you install the optional Serial Interface board).

The following programming options relate to the method in which the Remote Programmer software connects with the system.

### 10.3.1: Callback Telephone Number

RP Callback is a security feature that helps ensure that remote programming is only performed by authorized personnel. When the Remote Programmer contacts the panel, the panel hangs up and calls the Callback telephone number.

To edit the Callback telephone number:

1. From the Programming menu, select Communications, Remote Prog., Callback # [9521].
2. Enter up to 16 digits. Use the  key to enter “,” (pause), “T” (switch to DTMF tone dialing), “P” (switch to pulse dialing) or “+” (international code). Use the  key to delete one character at a time.
3. Press  when you have finished editing.



*If there is no Callback telephone number programmed, RP Callback is disabled and the system connects to the Remote Programmer software using the “direct call” method.*

### 10.3.2: RP Passcode

The RP passcode is a six-digit code that grants access to remote programming. When establishing an RP connection, the passcode programmed in the RP customer file on the PC must be identical to the system’s RP passcode.

To edit the RP passcode:

1. From the Programming menu, select Communications, Remote Prog., RP Passcode [9522].
2. Enter up to six digits.
3. Press  when you have finished editing.

### 10.3.3: RP Communication Interface

The *infinite* can employ either cellular or PSTN communication during remote programming.

For PSTN communication, the RP uses a double call method so that the line can be shared with regular telephone handsets, an answering machine or fax. The Cellular Communications Module has its own individual telephone number for data transfer and therefore, the double call method is not needed. In this case, the RP calls the control panel directly.

To program the RP communication interface:

1. From the Programming menu, select Communications, Remote Prog., RP Interface [9523].
2. Select either GSM or PSTN.

### 10.3.4: RP Access Options

Options are available to enable, disable or limit access to remote programming.

To program RP Access Options:

1. From the Programming menu, select Communications, Remote Prog., RP Access [9524].
2. Select an RP access option from the following table.

Access option	Description
Always	Up/downloading is always possible.
During Disarm	The system must be disarmed in order to establish a connection.
Disable	Up/downloading is disabled.



Table 10.2: RP Access Options

## 10.4: Service Call

The Service Call feature is designed to enable the user to call the monitoring service at the push of a button. When the user presses and holds down the Service Call button (0) for a few seconds, a two-way audio connection is established with the central station.

### 10.4.1: Service Call Telephone Number

To edit the Service Call telephone number:

1. From the Programming menu, select Communications, Service Call, Phone Number [9531].
2. Enter up to 16 digits. Use the  key to enter “,” (pause), “T” (switch to DTMF tone dialing), “P” (switch to pulse dialing) or “+” (international code). Use the  key to delete one character at a time.
3. Press  when you have finished editing.

### 10.4.2: Service Call Interface



For the Service Call feature, you can choose whether the system employs cellular or PSTN communication.

To program the Service Call interface:

1. From the Programming menu, select Communications, Service Call, Interface [9532].
2. Select either GSM or PSTN.

## 10.5: SMS Center

To edit the SMS Center telephone number:

1. From the Programming menu, select Communications, SMS Center [954].
2. Enter up to 16 digits. Use the  key to enter “,” (pause), “T” (switch to DTMF tone dialing), “P” (switch to pulse dialing) or “+” (international code). Use the  key to delete one character at a time.
3. Press  when you have finished editing.

## **10.6: Communications Options**

### **10.6.1: Line Monitor**

The Line Monitor feature monitors the PSTN telephone line. If a problem is detected, a Media Loss event is registered in the log.

To program the Line Monitor setting:

1. From the Programming menu, select Communications, Comm. Options, Line Monitor [9551].
2. Select Enable or Disable.

### **10.6.2: Periodic Test Interval**

The Periodic Test is a test transmission the system sends to notify the central station that its reporting capability is fully functional.

Two options are available for the Periodic Test:

- You can program the system to send a Periodic Test message according to a chosen time interval. This time interval can be between 1 and 254 hours (approximately 10 days).
- The system sends a weekly test and calculates automatically the time the Periodic Test is sent according to the last four digits of the account number. This feature ensures that the central station is not inundated by test reports at any given time.

To program the Periodic Test Interval:

1. From the Programming menu, select Communications, Comm. Options, Test Interval [9552].
2. Enter the test interval (001-254 hours) or 255 for an automatically calculated weekly test interval.
3. Press ✓ when the desired setting is displayed.

To disable the Periodic Test:

- Program the Periodic Test Interval as 000.

### **10.6.3: First Test**

If the Periodic Test Interval is programmed as 001-254 hours, you must also program the time that the first Periodic Test is sent.

To program the First Test Time:

1. From the Programming menu, select Communications, Comm. Options, First Test [9553].
2. Enter a time (HH:MM in 24hr format).
3. Press ✓ when the desired setting is displayed.

#### 10.6.4: Call Timeout

The Call Timeout is the amount of time the system waits for the first acknowledgement (ACK1) from the central station when reporting using the PSTN module. If ACK1 is not received during this time, the system regards the call as a failed dialing attempt.

To program the Call Timeout:

1. From the Programming menu, select Communications, Comm. Options, Call Timeout [9554].
2. Enter a time (001-255 seconds).
3. Press ✓ when the desired setting is displayed.

#### 10.6.5: ACK. Timeout

The ACK Timeout is the amount of time the system waits for the second acknowledgement (ACK2) from the central station when reporting using the PSTN module. If ACK2 is not received during this time, the system regards the call as a failed dialing attempt.

To program the ACK Timeout:

1. From the Programming menu, select Communications, Comm. Options, ACK Timeout [9555].
2. Enter a time (001-255 seconds).
3. Press ✓ when the desired setting is displayed.

#### 10.6.7: PSTN Country

In order to meet the requirements of local telecommunications authorities, default telephone line parameters have been chosen for a number of different countries.

To program the PSTN Country:

1. From the Programming menu, select Communications, Comm. Options, PSTN Country [9556].
2. Select your country from the options available.



*Electronics Line 3000 offers custom telephone line parameter settings for countries that do not appear in the list of pre-defined options. If your country does not appear among the available options, select the option Custom Settings.*

#### 10.6.8: Dial Tone Wait

This option determines whether the system dials only when the dial tone is present or if the dialing is initiated regardless of the dial tone.

To program the Dial Tone Wait option:

1. From the Programming menu, select Communications, Comm. Options, Dial Tone Wait [9557].
2. Select Enable or Disable.

## 10.7: Two-Way Audio Options

The *infinite* control panel offers a number of Two-Way Audio features that can be used in various applications. This section explains the programming options that control the mode in which these features function. For further information on Two-Way Audio, see Chapter Five: Two-Way Audio.

### 10.7.1: Incoming Two-Way Audio

This option determines whether the user/central station operator can establish Two-Way Audio communication with the control panel.

To program the Incoming Two-Way Audio setting:

1. From the Programming menu, select Communications, Comm. Options, Incoming TWA [95581].
2. Select Enable or Disable.

### 10.7.2: Two-Way Audio Timeout

The Two-Way Audio Timeout is the duration of a Two-Way Audio call. When the time out expires, the system automatically disconnects unless the call is manually extended by the operator.

To program the Two-Way Audio Timeout:

1. From the Programming menu, select Communications, Comm. Options, TWA Timeout [95582].
2. Enter a time (001-255 seconds).
3. Press ✓ when the desired setting is displayed.

### 10.7.3: Microphone/Speaker Options (for future use)

In addition to the built-in microphone and speaker, the *infinite* control panel supports an external microphone speaker unit. The Microphone/Speaker options allow you to choose which microphone and speaker shall function during Two-Way Audio communication. You can choose one mic./speaker (internal or external) to function exclusively or both may function simultaneously.

To program the Microphone/Speaker options:

1. From the Programming menu, select Communications, Comm. Options, Mic./Speaker [95583].
2. Select one of the available options.

## 10.8: GSM RX Report

The GSM RX Report is a feature that periodically reads the GSM signal strength of the Cellular Communications module – see 4.7.8: *GSM Signal Strength*.

This reading occurs at the times programmed for the Periodic Test – see 10.6.2: *Periodic Test Interval* & 10.6.3: *First Test*. This means that each time the periodic test is sent, the system also sends a GSM signal strength report to the central station. The system also enters the GSM signal strength in the event log.



*If the Periodic Test is disabled, the GSM RX Report feature will not function.*

*The GSM RX report belongs to the Peripherals event group – see 10.9: Event Options. If this event group is disabled, the GSM signal strength is still recorded in the event log.*

To program the GSM RX Report option:

1. From the Programming menu, select Communications, Comm. Options, GSM RX Report [9559].
2. Select Enable or Disable.

## **10.9: Event Options**

System events are divided into a number of different event groups. This division allows you to enable or disable reporting or Two-Way Audio for a specific group of events.

The different event groups are as follows:

- Burglary [#1]
- Fire [#2]
- Open/Close (arm/disarm) [#3]
- Service [#4]
- Power [#5]
- Peripherals [#6]
- RF Jamming [#7]
- Medical [#8]

### **10.9.1: Event Reporting**

You can enable or disable event reporting per Event Group. This allows you to filter the type of events that are reported to the central station.

To enable/disable reporting for an event group:

1. From the Programming menu, select Communications, Event Options [956].
2. Select an Event Group.
3. If the event group you have selected is Burglary, Fire or Medical, select Report (#1). For all other event groups, go to step 4.
4. Select Enable or Disable.

### **10.9.2: Two-Way Audio**

For Burglary, Fire and Medical event groups, there is an additional option that enables Two-Way Audio for that event group – see 5.2.2: *TWA Alarm Reporting*.

To enable/disable Two-Way Audio for an event group:

1. From the Programming menu, select Communications, Event Options [956].
2. Select an Event Group (Burglary, Fire or Medical).
3. Select TWA (#2).
4. Select Enable or Disable.



# Chapter Eleven: Home Automation Programming

This chapter explains the programmable options for the system's home automation features. The Home Automation module is an add-on optional extra that you can install inside the panel's plastic housing.

## 11.1: X10 Overview

The control panel's home automation feature employs the X10 protocol and this enables compatibility with a wide variety of readily available home automation products.

Before you can start programming the system's Home Automation features, you should be familiar with the basic concept behind X10 automation.

X10 is a protocol that enables you to send commands and other data over regular existing powerlines. This means that, using an X10 transmitter (the panel's Home Automation module), you can send On/Off commands to X10 receivers (lamp and appliance modules) that are plugged into electricity outlets around the home. From here on, we shall refer to these X10 receivers as "HA units".

Each HA unit has two codes that are used for identification. These codes are known as the House code and the Unit code and are usually defined by adjusting the dials that appear on the X10 unit. In Figure 11.1, the HA unit is set to House A, Unit 3.

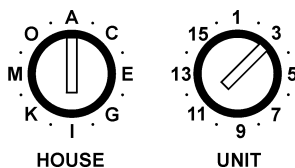

Figure 11.1: HA Unit Dials

The control panel supports sixteen HA units on one House code. To ensure that the Home Automation features function correctly, you must abide by the following guidelines.

- The House code must be the same on each HA unit.
- The House code on the HA units must be identical to the House code programmed in the panel's memory – see section 11.3: House Code.

## 11.2: HA Units

The following sections explain the programming options available for HA units.

### 11.2.1: Scheduling

Scheduling allows you to program the panel to send On/Off commands to an HA unit at specific times. The Scheduling section of Home Automation programming is identical to that described in Chapter Six: Home Automation Control. For further information on programming the On Time, Off Time and Schedule for each HA unit, see section 6.4: Scheduling.

### **11.2.2: On by Zone**

The On by Zone feature allows you to choose two zones that activate the HA unit when triggered. When either one of these zones is triggered, the system sends an On command to the HA unit according to the unit's programmed Pulse Time – see 11.2.7: *Pulse Time*. For example, you have a magnetic contact installed above the front door. When the door is opened, the hall light is lit.

To select the sensors that activate an HA unit:

1. From the Programming menu, select HA Programming, HA Units [961].
2. Select an HA unit (01-16).
3. From the HA unit's sub-menu, select On by Zone [#4].
4. Enter up to two zone numbers.
5. Press ✓ when the desired setting is displayed.

### **11.2.3: On by Arm**

The On by Arm feature activates the HA unit when the system is armed using any of the arming methods. The amount of time the HA unit is activated is determined by the Pulse Time – see 11.2.7: *Pulse Time*. If the Pulse Time is programmed as "Toggle", disarming the system switches the HA unit off.

To program the On by Arm feature:

1. From the Programming menu, select HA Programming, HA Units [961].
2. Select an HA unit (01-16).
3. From the HA unit's sub-menu, select On by Arm [#5].
4. Select Enable or Disable.

### **11.2.4: Keyfob Control**

Each EL-2614 keyfob, offers control of up to two individual HA units. This programming option allows you to enable or disable this feature per HA unit.

To program the keyfob control option for an HA unit:

1. From the Programming menu, select HA Programming, HA Units [961].
2. Select an HA unit (01-16).
3. From the HA unit's sub-menu, select KF Control [#6].
4. Select Enable or Disable.

### **11.2.5: SMS Control**

Via SMS, you can send commands to the system in order to control various HA units. This option allows you to enable or disable this feature for each HA unit.

To program the SMS control option for an HA unit:

1. From the Programming menu, select HA Programming, HA Units [961].
2. Select an HA unit (01-16).
3. From the HA unit's sub-menu, select SMS Control [#7].
4. Select Enable or Disable.

### **11.2.6: Randomize**

When the system is fully armed between the hours 21:00 and 06:00, the Randomize feature turns HA units on and off at random. This gives the impression that the house is occupied and acts as a deterrent against potential intruders.

To program an HA unit to be included in the Randomize feature:

1. From the Programming menu, select HA Programming, HA Units [961].
2. Select an HA unit (01-16).
3. From the HA unit's sub-menu, select Randomize [#8].
4. Select Enable or Disable.

### **11.2.7: Pulse Time**

The Pulse Time determines the manner in which an HA unit responds to the On command. You can program each HA unit switch on momentarily. This means that, on receiving the On command, the unit will be switched on for a programmed amount of time. For example, you can program the hall light to switch on for 1 minute and automatically switch itself off. Alternatively, the HA unit can be programmed to toggle on and off.

To program the Pulse Time for an HA unit:

1. From the Programming menu, select HA Programming, HA Units [961].
2. Select an HA unit (01-16).
3. From the HA unit's sub-menu, select Pulse Time [#9].
4. Select 5 sec, 30 sec, 1 min, 2 min or Toggle.

### **11.2.8: Descriptor**

You can assign a 16-character descriptor for each HA unit. These descriptors help the user to identify the various HA units installed around the home.

To edit an HA unit descriptor:

1. From the Programming menu, select HA Programming, HA Units [961].
2. Select an HA unit (01-16).
3. From the HA unit's sub-menu, select Descriptor [#0].
4. Edit the descriptor using the alphanumeric keypad.
5. Press ✓ when you have finished editing.

## **11.3: House Code**

The House code is part of the identification code of each HA unit. For the Home Automation features to function correctly, the House code on each HA unit must be identical to the House code programmed in the system's memory.

To program the system House code:

1. From the Programming menu, select HA Programming, House Code [962].
2. Select a House code from the options available (A-P).

## **11.4: SMS Confirmation**

After an SMS command is executed by the system, a confirmation message is returned to the sender's mobile phone. You can enable or disable this feature using this option.

To enable/disable SMS confirmation:

1. From the Programming menu, select HA Programming, SMS Confirm. [963].
2. Select Enable or Disable.

# Chapter Twelve: System Initialization

---

The Initialization menu offers a number of options that enable you to reset the system. This menu is particularly useful when re-installing a panel at a new site. The Initialization function clears the entire system. This restores programming defaults, clears the log, user codes and the transmitter register. Options are also available that enable you to clear a specific section of the system's memory separately.

## ***12.1: Initialization***

The Initialization function clears the entire system and resets factory defaults.

To initialize the control panel:

1. From the Programming menu, select Initialize, Init All [971]; the system prompts you for confirmation.
2. Press ✓ to confirm; factory programming defaults are restored, the event log is cleared, user codes and wireless transmitters are deleted.

## ***12.2: Default Program Restore***

Loading the system's default program enables you to restore the factory-set programming defaults.

To load the default program:

1. From the Programming menu, select Initialize, Load Defaults [972]; the system prompts you for confirmation.
2. Press ✓ to confirm; factory programming defaults are restored.

## ***12.3: Clear User Codes***

Clear User Codes deletes all programmed user codes and restores the default Master and Installer codes.

To clear user codes:

1. From the Programming menu, select Initialize, Clear Users [973]; the system prompts you for confirmation.
2. Press ✓ to confirm; all user codes are deleted and default codes are restored.

## ***12.4: Clear Wireless Transmitters***

The Clear Wireless Transmitters function enables you to delete all registered transmitters at once.

To clear the transmitter register:

1. From the Programming menu, select Initialize, Clear Wireless [974]; the system prompts you for confirmation.
2. Press ✓ to confirm; the transmitter register is cleared.

## 12.5: Find Modules

There are three optional modules that you can connect to the system bus. These are the PSTN module, the GSM module and the Home Automation module. The Find Modules function runs a diagnostic test that identifies the modules that are connected to the system bus. With this information, the system knows which add-on modules should be present enabling supervision for those modules.

To run the Find Modules test:

1. From the Programming menu, select Initialize, find Modules [975]; the system prompts you for confirmation.
2. Press ✓ to confirm; the system begins to search for the connected modules. At the end of the search, the modules that are present are displayed and the system asks if you want to save the displayed list.
3. Press ✓ ; the list is saved.



*If a connected module is not included in the list, check the wiring connections and run this test again.*

# Appendix A: Menu Structure

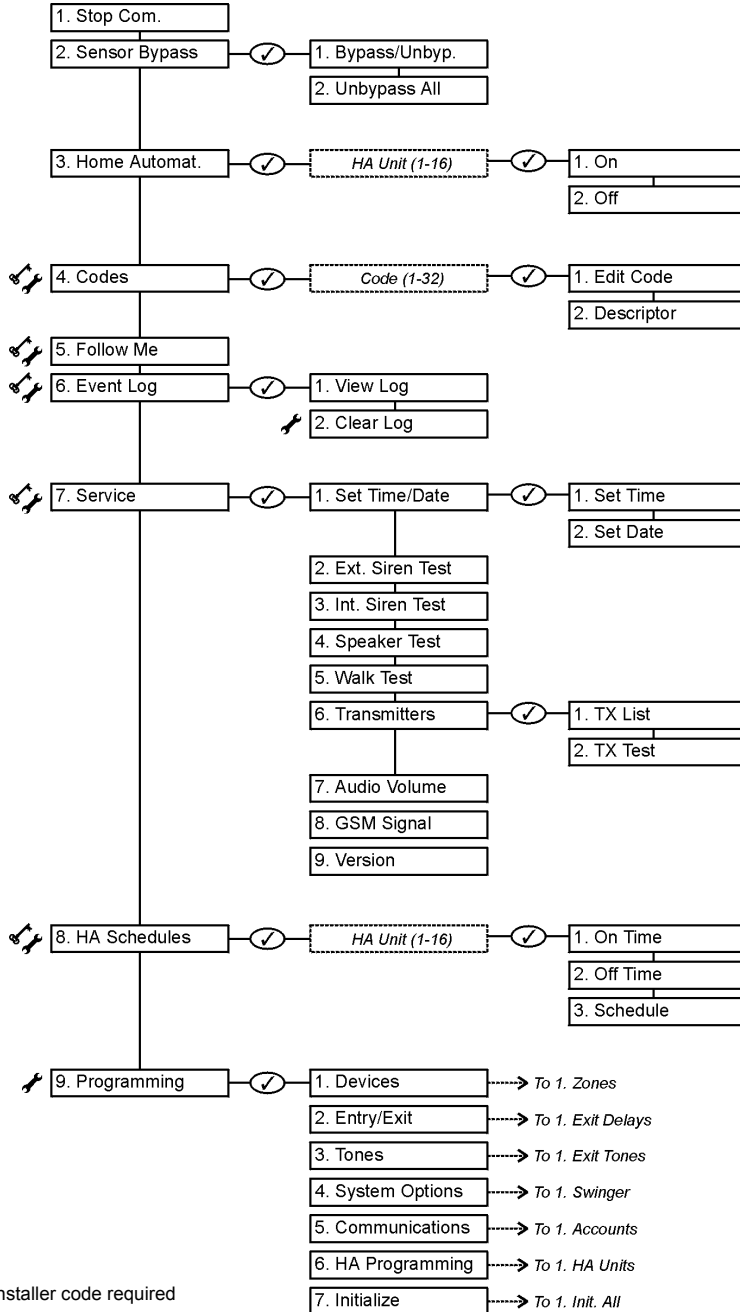

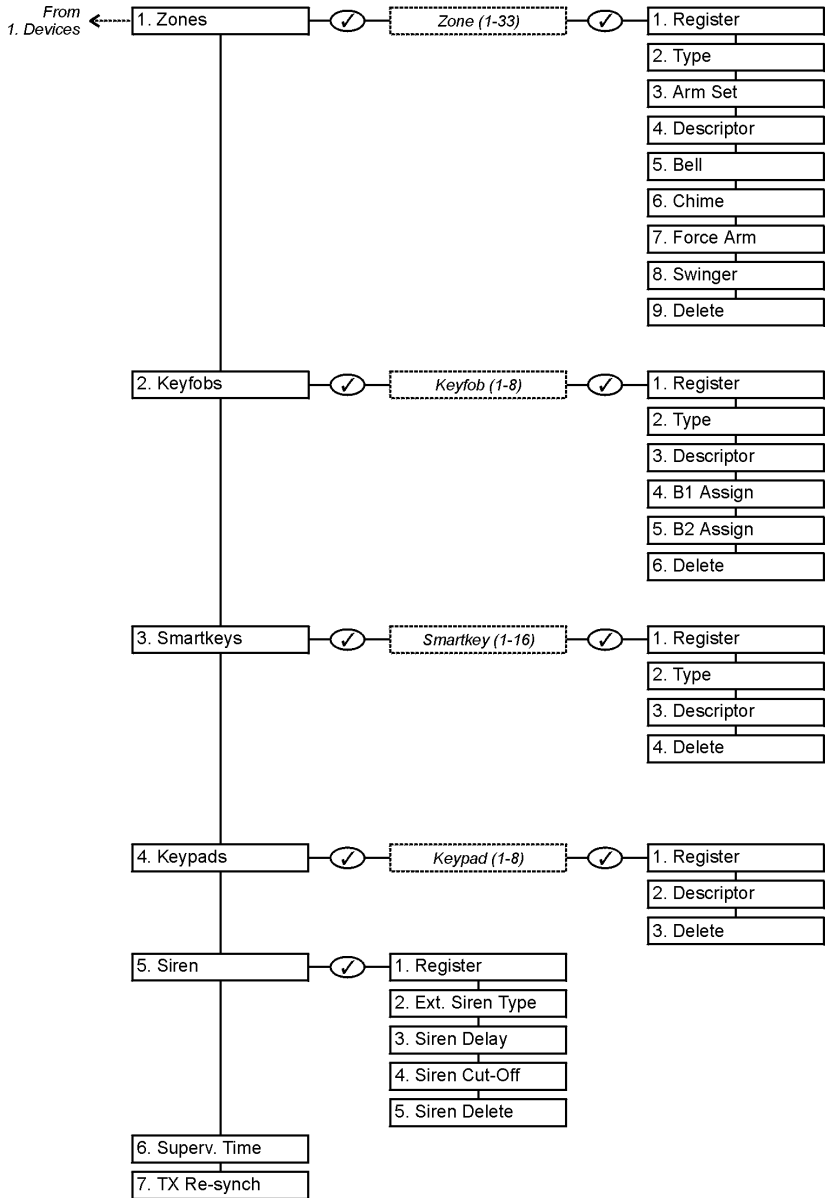

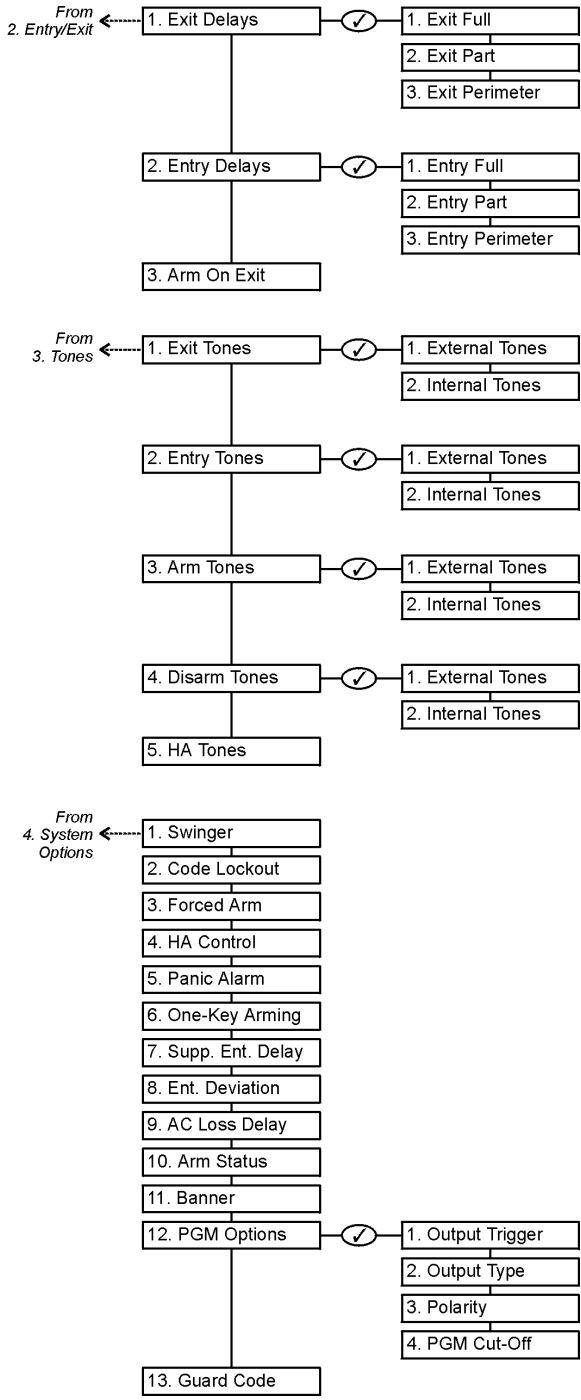



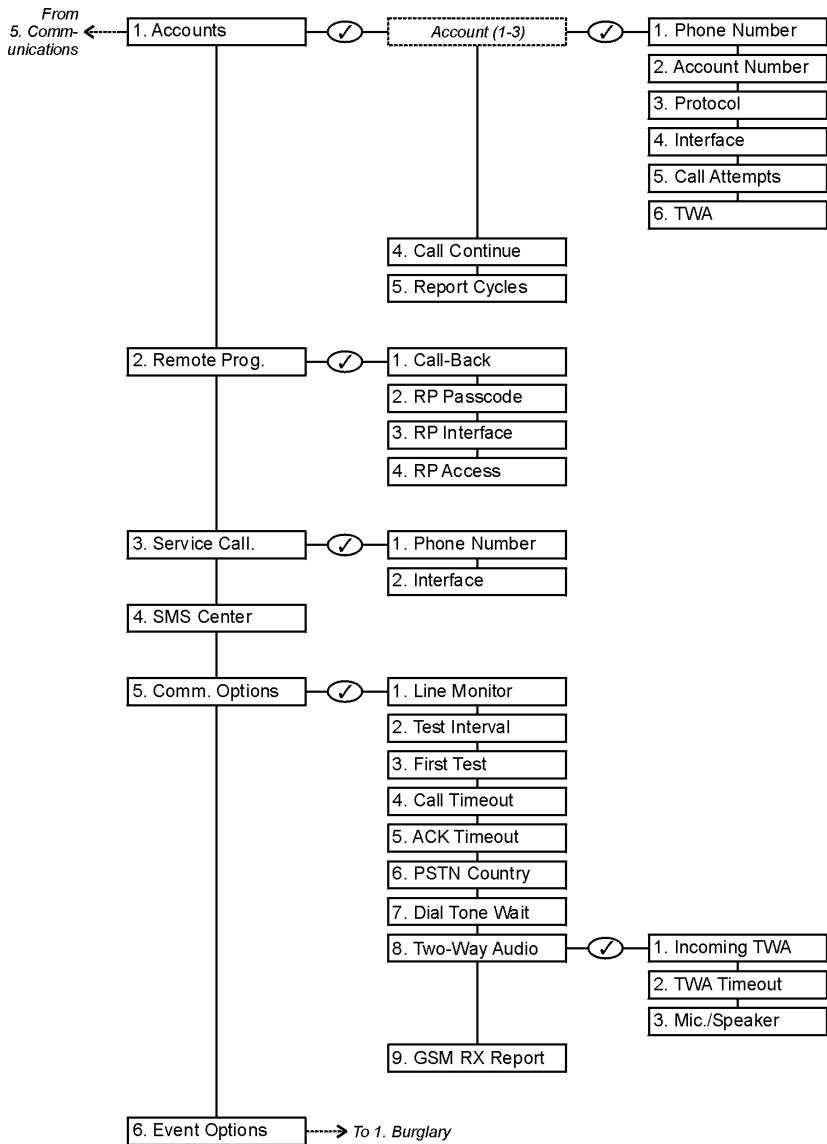

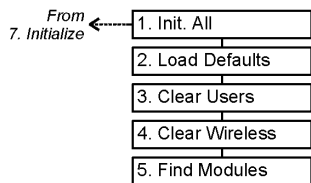
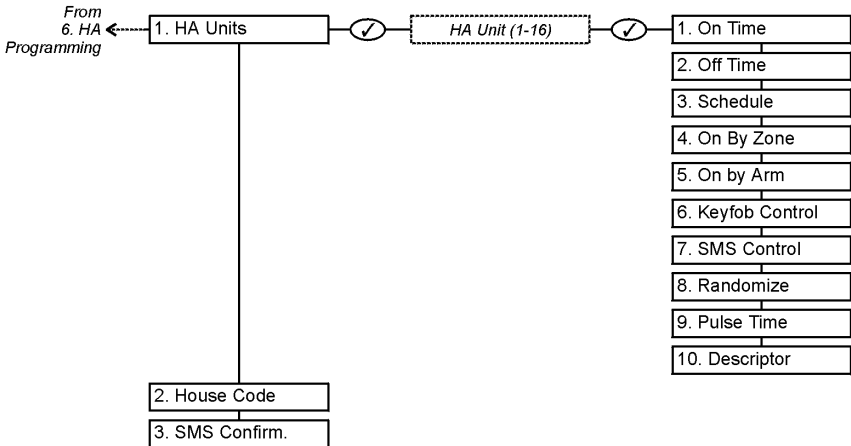
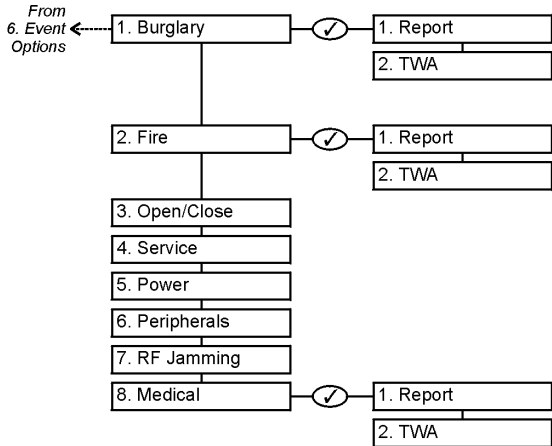

# Appendix B: Transmitter Installation

## PIR Sensors (EL-2600/EL-2600PI)

The EL-2600 and EL-2600PI are intelligent wireless PIR sensors for use with the *infinite* system. Both sensors implement a feature to combat the problem of multiple transmissions, which drastically reduce the life of the batteries. After each transmission, there is a four-minute delay during which further transmissions will not be sent.

The EL-2600PI is designed for installations prone to nuisance alarms caused by pets or small animals.

### Considerations Before Installation

- Select a location from which the pattern of the detector is most likely to be crossed by a burglar, should there be a break in.
- Do not place bulky objects in front of the detector.
- Avoid a location which comes in direct contact with radiators, heating/cooling ducts and air conditioners.
- Select an appropriate installation height from the following table:

Lens	Mounting Height
Standard	2.2m (6.6ft)
Long Range	2m (6.5ft)
Curtain	1m (3.25ft)
EL-2600PI	2m (6.5ft)

Table B.1: Recommended Mounting Height

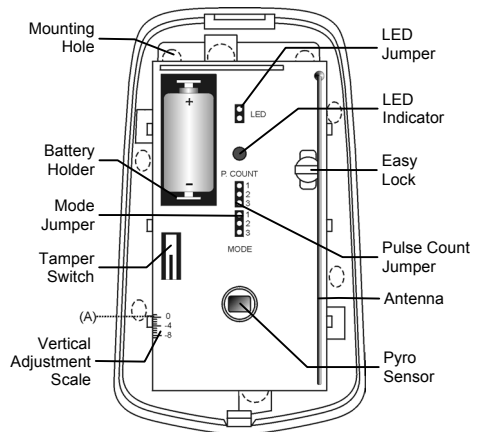

Figure B.1: EL-2600/EL-2600PI (cover off)



The vertical adjustment scale relates to the top edge of the adjacent plastic stud (A).

### Pet Immunity Guidelines (EL-2600PI)

It is expected that the EL-2600PI will eliminate false alarms caused by animals (up to 22kg/50lbs), several small rodents and random flying birds.



The weight of the animal should only be used as a guide, other factors such as the length and color of fur also affect the level of immunity.

For maximum pet immunity the following guidelines are recommended:

- Mount the center of the unit at a height of 2m with the PCB vertical setting at -4.
- Set the pulse counter to 2 (place the jumper over pins 2 & 3).
- Do not aim the detector at stairways that can be climbed by an animal.
- Avoid a location where an animal can come within 1.8m of the detector by climbing on furniture, boxes or other objects.

### Installation Procedure

To install PIR sensors:

1. Open the housing by removing the front cover. To do so, insert a screwdriver in the release slot (located at the bottom of the detector between the front and back cover). Turn the screwdriver 90° to release the cover.

2. Remove the PCB by turning counter-clockwise and removing the Easy Lock – *do not touch the face of the pyro sensor!*
3. Apply battery power by removing the isolator that separates the battery from the contacts on the battery holder.
4. Place the Mode jumper over pins 2 & 3 (Radio Mode); the LED flashes.



*Install the Mode jumper only after applying battery power.*

5. From the Programming menu, select Devices, Zones [911].
6. Select the zone to which you want to register the transmitter; the system initiates Registration mode. When **Save?** appears on *infinite's* LCD display, press ✓.
7. Remove the Mode jumper and place it over one pin for storage.
8. Choose an appropriate mounting height from Table B.1 and test the transmitter from the exact mounting position before permanently mounting the unit.
9. Knock out the mounting holes and attach the base to the wall.
10. Mount the PCB at the required vertical adjustment and replace the PCB screw.
11. Replace the front cover.

### Warm-Up Time

The detector will need to warm up for the first 90 seconds after applying power.

### Pulse Counter

The pulse counter determines the amount of pulses that need to be received for the detector to generate an alarm. To set the pulse counter, refer to Table B.2.

Jumper Position	Pulse Count
Pins 1&2	1
Pins 2&3	2
Jumper Removed	3

Table B.2: Pulse Count Jumper

### Vertical Adjustment

To position the PCB, turn the Easy Lock counter-clockwise and slide the PCB up or down to the required setting using the vertical adjustment scale. The detector's coverage area is 14m x 14m when the PCB is positioned at 0. Slide the PCB up towards the -8 position to decrease the coverage area bringing the beams closer to the mounting wall.

### Walk Test Mode

A walk test is performed in order to determine the lens coverage pattern of the detector – see *Figures 2*. Walk Test mode cancels the delay time between detections, enabling you to perform an efficient walk test.

To perform a Walk Test.

1. Place the Mode jumper over pins 1 & 2.
2. Walk across the scope of the detector according to the detection pattern selected.
3. Confirm that the LED activates and deactivates accordingly. Wait five seconds after each detection before continuing the test.
4. After completing the walk test, remove the jumper and place it over one pin for storage – see *Mode Jumper Safeguard*.

### LED Indication

The LED indicator is lit twice every time a transmission is made. Insert the LED jumper to enable LED indication and remove the LED jumper to disable LED indication.

## Mode Jumper Safeguard

During normal operation, the Mode jumper should be placed over one pin for storage. When the mode jumper is placed over two pins, the detector is either in Registration or Walk Test Mode. As a precaution, these modes are limited to four minutes. After four minutes have expired, the detector switches back to normal operation. If this happens, you can reset a mode by removing and replacing the mode jumper.

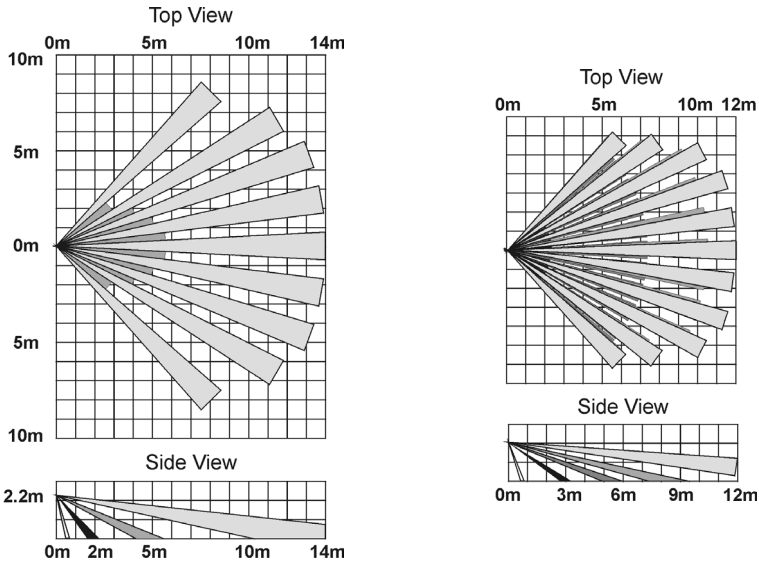

Figure B.2: Lens Coverage Diagrams EL-2600 (left) and EL-2600PI (right)

## Magnetic Contact (EL-2601)

The EL-2601 is a magnetic contact designed for installation on doors and windows.

### Installation Procedure

To install magnetic contacts.

1. To open the housing, insert a small screwdriver at the bottom of the unit between the front and back cover and twist the screwdriver to release the cover.
2. Remove the divider separating the battery from the contacts on the battery holder. When you apply power and the Tamper switch is open, the EL-2601 enters Test mode during which a transmission is sent every few seconds. You can terminate Test mode by closing the Tamper switch. Test mode is automatically terminated after approximately five minutes.
3. From the Programming menu, select Devices, Zones [911].
4. Select the zone to which you want to register the transmitter; the system initiates Registration mode. When **Save?** appears on *infinite's* LCD display, press ✓.

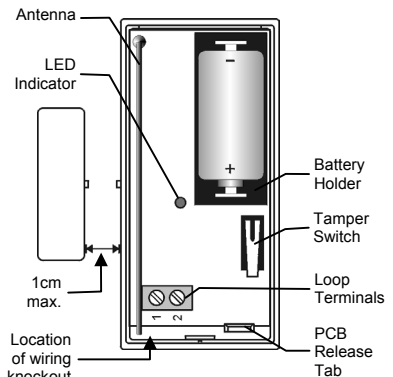

Figure B.3: EL-2601 (cover off)

5. After registration, press the EL-2601's tamper switch to terminate Test mode.
6. Before permanently mounting the unit, test the transmitter from the exact mounting position.
7. To remove the PCB, press the PCB release tab and carefully lift the board and slide the board away from the back cover.
8. The EL-2601 is provided with terminal 1 shorted to terminal 2. If connecting a wired contact loop, disconnect the wire bridge and connect the terminal block as follows: 1 - Alarm; 2 - GND. For this purpose, a wiring knockout is provided in the back cover.
9. Mount the back cover using two screws and replace the PCB.
10. To open the magnet's housing, insert a small screwdriver into one of the pry-off slots located at either end of the magnet's back cover and lift to separate from the front cover.
11. Mount the back cover of the magnet using two screws. Make sure that the guideline on the magnet is correctly aligned with the guideline on the transmitter.



*Do not install the magnet further than 1cm from the transmitter.*

12. Test the transmitter, making certain that the LED is lit when opening the door/window and again when closing.
13. Close the front covers of the transmitter and the magnet.

## Smoke Detector (EL-2603)

The EL-2603 is a brand-name smoke detector with an integrated Electronics Line 3000 transmitter.

### Installation Procedure

The following procedure explains the installation of the EL-2603 wireless smoke detector and its registration to the receiver. For further information regarding the smoke detector's location, test procedures, maintenance and specifications, refer to the manufacturer's installation instructions provided with this product.

To install smoke detectors:

1. Open the cover by lifting the opening tab while firmly holding the base with your other hand.
2. Push the cover backwards to separate the cover from the base.
3. Install a 9V battery into the detector's battery snap.
4. Insert the Test jumper; the EL-2603 enters Test mode and the LED flashes every few seconds.
5. From the Programming menu, select Devices, Zones [911].
6. Select the zone to which you want to register the transmitter; the system initiates Registration mode. When **Save?** appears on *infinite's* LCD display, press ✓.

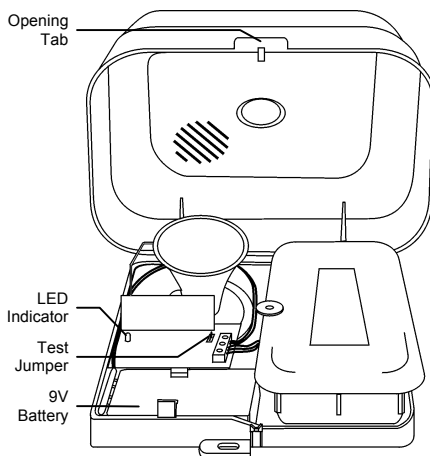

Figure B.4: EL-2603 (cover open)

7. After registration, remove the Test jumper and place it over one pin for storage.
8. Before permanently mounting the unit, test the transmitter from the exact mounting position.
9. Attach the mounting base to the ceiling using the screws provided.
10. Replace the cover onto its hinges and close the cover until it snaps together with the base.

## Keyfobs (EL-2611/EL-2614)

The EL-2611 and EL-2614 are keyfob transmitters that are supported by the *infinite* system.

### Registration Procedure

To register keyfobs:

1. From the Programming menu, select Devices, Keyfobs [912].
2. Select the keyfob you want to register; the system initiates Registration mode.
3. Press a button, making sure that the keyfob's LED lights up when the button is pressed.
4. Press the same button again. When **Save?** appears on *infinite*'s LCD display, press ✓.

### EL-2611

The EL-2611 is a one-button transmitter that generates a Medical Emergency alarm when pressed. The transmitter is water resistant and can be worn around the neck. Its large button makes it ideal for elderly or sight-impaired users.

When the battery is low, the EL-2611's LED flashes during transmission and a Low Battery signal is sent to the receiver. When either of these two indications are observed, replace the unit.



Figure B.5: EL-2611



Figure B.6: EL-2614

### EL-2614

The EL-2614 is a four-button keyfob transmitter that offers a number of functions including arm, disarm and SOS Panic.

When the battery is low, the EL-2614's LED flashes during transmission and a Low Battery signal is sent to the receiver. When either of these two indications are observed, replace the batteries.

To replace the batteries:

1. Insert a small screwdriver into the pry-off slot – see *Figure B.7*. Carefully twist the screwdriver to separate the front and back of the casing.
2. Observing correct polarity, replace the batteries (3V lithium, size: CR1225).
3. Close the casing making sure that the front and back click shut.

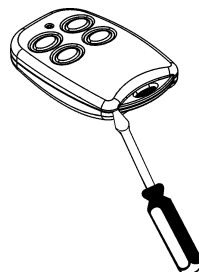



Figure B.7: Opening the EL-2614's Casing

## Wireless Keypads (EL-2620/EL-2640)

The EL-2620 and EL-2640 are one-way wireless keypads primarily designed as additional arming stations, including three arming keys that enable Full, Part or Perimeter arming modes. Pressing the Full and Perimeter buttons simultaneously generates an SOS panic alarm. Additionally, the keypad may be used to control Home Automation modules.

The EL-2620 also includes an additional Cancel key, , that clears the keypad in the event that a key is pressed by mistake while entering a code, for example. This key causes the keypad to disregard what was previously entered enabling the user to start again.

### Registration Procedure

To register wireless keypads:

1. From the Programming menu, select Devices, Keypads [914].
2. Select the keypad you want to register; the system initiates Registration mode.
3. Press a button on the keypad making sure that a LED lights up when the button is pressed.
4. Press the same button again. When **Save?** appears on *infinite's* LCD display, press .

### Battery Replacement (EL-2620)

Every time a key is pressed, one of the battery status LEDs is lit. When the battery needs to be replaced, the red Low Battery LED is lit.

To replace the battery:

1. Insert a small screwdriver into the pry-off slots at the bottom of the unit and twist to remove the back cover.
2. Observing correct polarity, replace the battery (9V, alkaline).
3. Replace the back cover making sure that the two covers click shut.

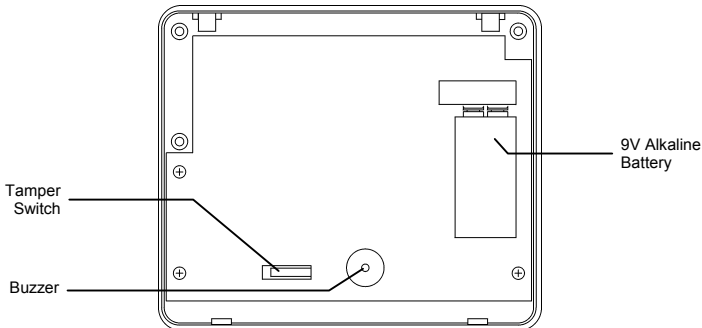

Figure B.10: EL-2620 (back cover off)

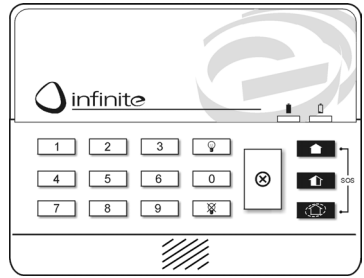

Figure B.8: EL-2620

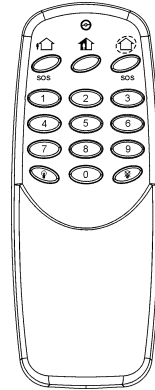

Figure B.9: EL-2640



### Battery Replacement (EL-2640)

When the battery is low, the EL-2640's LED flashes during transmission.

To replace the battery:

1. Remove the battery cover located at the rear of the unit. To do so, press the release tab using a small screwdriver and lift the cover away from the EL-2640's plastic housing.
2. Observing correct polarity, replace the battery (9V, alkaline).
3. Replace the battery cover making sure that it clicks shut.

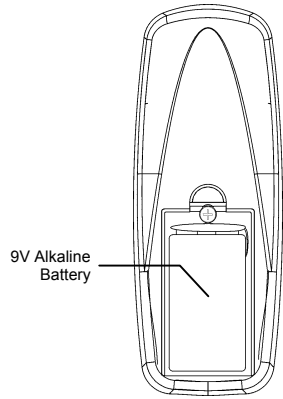

**Figure B.11: EL-2640  
(battery cover off)**

## Transmitter Specifications

The technical specifications for the transmitters that appear in this appendix are listed below. All transmitters are available in 868.35, 433.92 or 418MHz FM frequencies.

### EL-2600

Antenna: Built-in Whip  
Power: 3.6V ½ AA Lithium Battery  
Current Consumption: 30mA (transmission)  
6µA (standby)

Pyroelectric Sensor: Dual Element  
Maximum Coverage: 14 x 14m  
Pulse Count: 1, 2 or 3 Jumper Selectable  
LED Indicator: Jumper Selectable  
Adaptive Temperature Compensation  
RFI Immunity: 30V/m  
Operating Temperature: -10 to 60°C  
Fire Protection: ABS Plastic Housing  
Dimensions: 110 x 60 x 45mm

### EL-2600PI

Antenna: Built-in Whip  
Power: 3.6V ½ AA Lithium Battery  
Current Consumption: 30mA (transmission),  
6µA (standby)

Pyroelectric Sensor: Dual Element  
Maximum Coverage: 12 x 12m  
Pulse Count: 1, 2 or 3 Jumper Selectable  
LED Indicator: Jumper Selectable  
Adaptive Temperature Compensation  
RFI Immunity: 30V/m  
Operating Temperature: -10 to 60°C  
Fire Protection: ABS Plastic Housing  
Dimensions: 110 x 60 x 45mm

### EL-2601

Antenna: Built-in Whip  
Power: 3.6V ½ AA Lithium Battery  
Current Consumption: 25mA (transmission)  
10µA (standby)  
Loop Input Voltage Range: 0-15VDC/AC  
(peak to peak)

RFI Immunity: 40V/m  
Operating Temperature: 0 to 60°C  
Dimensions: 65 x 30 x 25mm

### EL-2603

Antenna: Built-in Internal Whip  
Current Consumption: 30mA (transmission),  
20µA (standby)

Power: 9V Alkaline Battery  
RFI Immunity: 40V/m  
Operating Temperature: 0-60°C  
Dimensions: 138 x 118 x 44mm

### EL-2611

Antenna: Built-in Whip  
RFI Immunity: 40V/m  
Operating Temperature: 0 to 60°C  
Dimensions: 60 x 40 x 15mm

### EL-2614

Antenna: Built-in Whip  
Power: 2 x 3V Lithium Battery  
Size CR1225  
Current Consumption: 16mA (transmission)  
2µA (standby)  
RFI Immunity: 40V/m  
Operating Temperature: 0 to 60°C  
Dimensions: 62 x 42 x 15mm

### EL-2620

Antenna: Built-in Whip  
Current Consumption: 26mA (transmission)  
2µA (standby)  
Power: 9V Alkaline Battery  
RFI Immunity: 40V/m  
Operating Temperature: 0 to 60°C  
Dimensions: 130 x 110 x 28mm

### EL-2640

Antenna: Built-in Whip  
Current Consumption: 25mA (transmission)  
3µA (standby)  
Power: 9V Alkaline Battery  
RFI Immunity: 40V/m  
Operating Temperature: 0 to 60°C  
Dimensions: 128 x 49 x 27mm



*Fire, explosion and severe burn hazard!*

*When handling lithium batteries follow the listed precautions:*

- *Do not recharge.*
- *Do not deform or disassemble.*
- *Do not heat above 100°C or incinerate.*