



**Powered
by Vodafone**

Cellcom*Prime*

Advanced GSM Intercom

- Calls your home phone and mobiles on roll-over when visitor presses call button.
- Never miss a visitor with mobile calling.
- Works with any standard contract or Pre-Pay GSM Micro SIM card.
- Comes with optional Vodafone™ 12 month contract SIM, unlimited calls and texts for £7.50/month + VAT* (terms and conditions apply, zone 1 Europe only).
- Free home owner app to trigger gates, set up auto opening and closing times, create new access codes, receive notifications on entry, etc.
- Free installer app for remote programming and diagnostics.

Cellcomprime

Advanced GSM Intercom



-  Set automatic gate open & close times.
-  Do-not-disturb watershed time.
-  User history log to your phone.
-  Illuminated call button and keypad.
-  Add keypad codes by App.
-  Issue time restricted codes.
-  High gain antenna as standard!
-  2x Relays

Home Owner /User App Screens

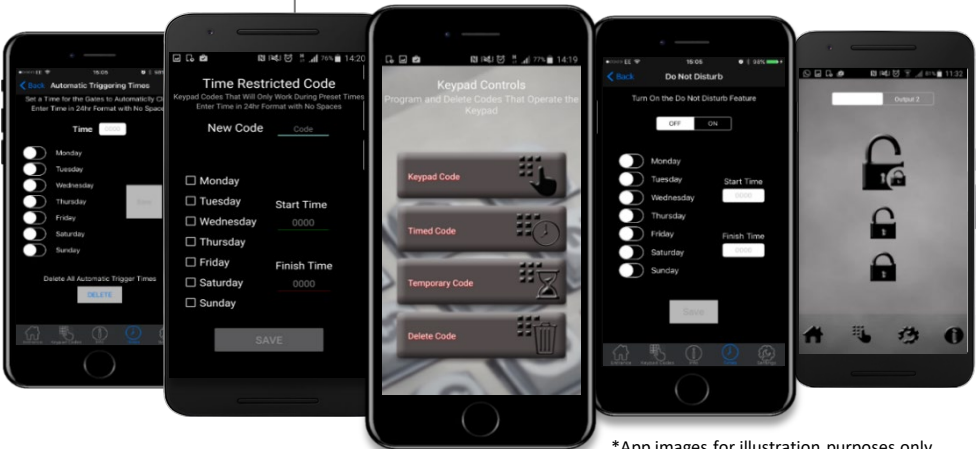

*App images for illustration purposes only.

Cellcomprime

Advanced GSM Intercom



Create a list of all your installs for later editing or diagnostics

Complete menu of all parameters for editing by app

*App images for illustration purposes only.

Program auto opening and closing times

Program phone numbers easily!

Technical Details			
Dial Out Numbers	4	Relays	2
Permanent Codes	200	Relay Type	N/C and N/O
Time Restricted Codes	20	Relay Load	2 amps, 24v ac max
Temporary Codes	30	Power Consumption	300mA on dial out, 2amp peak demand
Automatic Trigger Events per Week	40	Modem Models	2G quad band, 4G Europe, 4G USA, 4G AUS/NZ
Caller ID Numbers	100		
Time Restricted Caller ID Numbers	20	Power Supply	24v dc (24v 2A dc adaptor included)

Cellcomprime

Advanced GSM Intercom

Imperial Panel

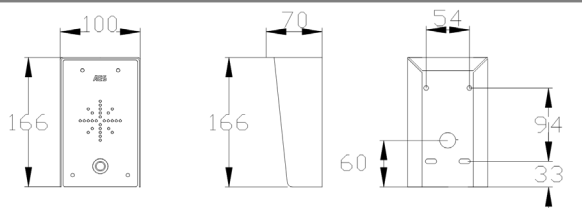
													
<p>Ultra stylish all black panel with textured powder coated aluminium hood and gloss black acrylic facia trim over a tough metal back plate. Complete with modern white illuminated push button.</p>	<table border="1"> <tr> <td>GSM-5IMP</td> <td>2G</td> <td>Europe *limited connectivity</td> </tr> <tr> <td>PRIME6-IMP/4GE</td> <td>4G</td> <td>Europe</td> </tr> <tr> <td>PRIME6-IMP/4GA</td> <td>4G</td> <td>USA</td> </tr> <tr> <td>PRIME6-IMP/4GSA</td> <td>4G</td> <td>Australia & NZ</td> </tr> </table>	GSM-5IMP	2G	Europe *limited connectivity	PRIME6-IMP/4GE	4G	Europe	PRIME6-IMP/4GA	4G	USA	PRIME6-IMP/4GSA	4G	Australia & NZ
GSM-5IMP	2G	Europe *limited connectivity											
PRIME6-IMP/4GE	4G	Europe											
PRIME6-IMP/4GA	4G	USA											
PRIME6-IMP/4GSA	4G	Australia & NZ											

Imperial Panel with Keypad

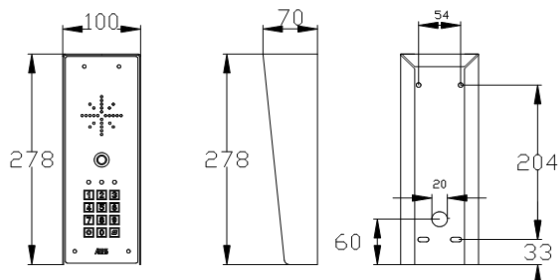
													
<p>Ultra stylish all black panel with textured powder coated aluminium hood and gloss black acrylic facia trim over a tough metal back plate. Complete with modern white illuminated buttons.</p>	<table border="1"> <tr> <td>GSM-5IMP</td> <td>2G</td> <td>Europe *limited connectivity</td> </tr> <tr> <td>PRIME6-IMP/4GE</td> <td>4G</td> <td>Europe</td> </tr> <tr> <td>PRIME6-IMP/4GA</td> <td>4G</td> <td>USA</td> </tr> <tr> <td>PRIME6-IMP/4GSA</td> <td>4G</td> <td>Australia & NZ</td> </tr> </table>	GSM-5IMP	2G	Europe *limited connectivity	PRIME6-IMP/4GE	4G	Europe	PRIME6-IMP/4GA	4G	USA	PRIME6-IMP/4GSA	4G	Australia & NZ
GSM-5IMP	2G	Europe *limited connectivity											
PRIME6-IMP/4GE	4G	Europe											
PRIME6-IMP/4GA	4G	USA											
PRIME6-IMP/4GSA	4G	Australia & NZ											

Cellcomprime

Advanced GSM Intercom

Architectural Panel

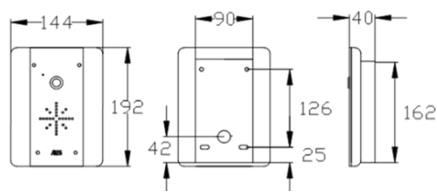
		
<p>Stylish curved architectural model. Constructed from BS316 marine grade stainless steel and finished with gloss black acrylic trim. Modern blue backlighting.</p>	<p>GSM-5AB 2G</p>	<p>Europe *limited connectivity</p>
	<p>PRIME6-AB/4GE 4G</p>	<p>Europe</p>
	<p>PRIME6-AB/4GA 4G</p>	<p>USA</p>
	<p>PRIME6-AB/4GSA 4G</p>	<p>Australia & NZ</p>

Architectural Panel with Keypad

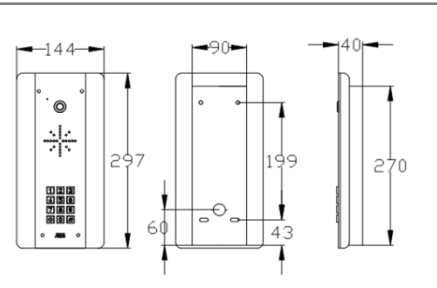
		
<p>Stylish curved architectural model. Constructed from BS316 marine grade stainless steel and finished with gloss black acrylic trim. Modern blue backlighting with integrated keypad.</p>	<p>GSM-5ABK 2G</p>	<p>Europe *limited connectivity</p>
	<p>PRIME6-ABK/4GE 4G</p>	<p>Europe</p>
	<p>PRIME6-ABK/4GA 4G</p>	<p>USA</p>
	<p>PRIME6-ABK/4GSA 4G</p>	<p>Australia & NZ</p>

Cellcomprime

Advanced GSM Intercom

Architectural Panel

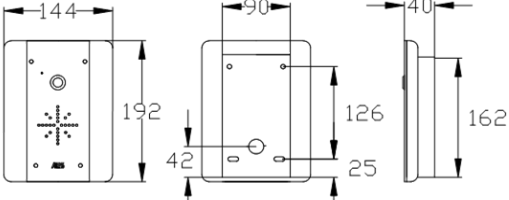
		
<p>Stylish curved architectural model in an attractive and rugged all brushed BS316 marine grade stainless steel with modern cool white back lighting illumination.</p>	<p>GSM-5AS 2G</p>	<p>Europe *limited connectivity</p>
	<p>PRIME6-AS/4GE 4G</p>	<p>Europe</p>
	<p>PRIME6-AS/4GA 4G</p>	<p>USA</p>
	<p>PRIME6-AS/4GSA 4G</p>	<p>Australia & NZ</p>

Architectural Panel with Keypad

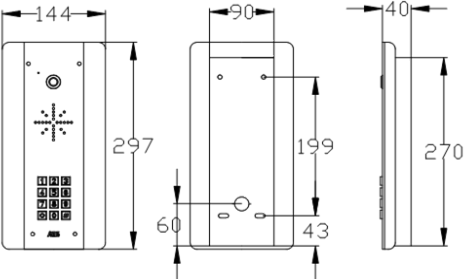
		
<p>Curved architectural model in an attractive and rugged all brushed BS316 marine grade stainless steel with modern cool white back lighting illumination and integrated keypad.</p>	<p>GSM-5ASK 2G</p>	<p>Europe *limited connectivity</p>
	<p>PRIME6-ASK/4GE 4G</p>	<p>Europe</p>
	<p>PRIME6-ASK/4GA 4G</p>	<p>USA</p>
	<p>PRIME6-ASK/4GSA 4G</p>	<p>Australia & NZ</p>

Cellcomprime

Advanced GSM Intercom

Industrial Panel non Keypad

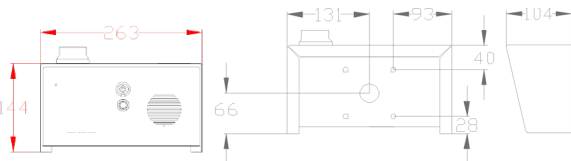
			
<p>Industrial version with keypad for pedestal mount, vehicle entrances, trucks and loud industrial applications. BS316 marine grade stainless steel construction with gloss black face trim.</p>	<p>GSM-5IMP-PED 2G</p>	<p>Europe *limited connectivity</p>	
	<p>PRME6-IMP-PED/4GE 4G</p>	<p>Europe</p>	
	<p>PRIME6-IMP-PED/4GA 4G</p>	<p>USA</p>	
	<p>PRIME6-IMP-PED/4GSA 4G</p>	<p>Australia & NZ</p>	

Industrial Panel with Keypad

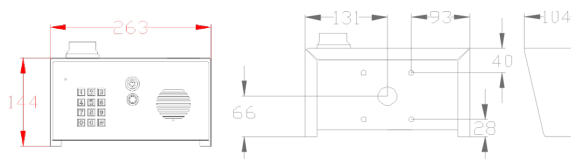
			
<p>Industrial version with keypad for pedestal mount, vehicle entrances, trucks and loud industrial applications. BS316 marine grade stainless steel construction with gloss black face trim.</p>	<p>GSM-5IMPK-PED 2G</p>	<p>Europe *limited connectivity</p>	
	<p>PRME6-IMPK-PED/4GE 4G</p>	<p>Europe</p>	
	<p>PRIME6-IMPK-PED/4GA 4G</p>	<p>USA</p>	
	<p>PRIME6-IMPK-PED/4GSA 4G</p>	<p>Australia & NZ</p>	